

DS-1272ZJ-110B

Wall Mounting Bracket for
Dome Camera (with Junction Box)

Features:

- Aluminum alloy material with surface spray treatment
- Design of cable entrance hole
- Better water proof design
- Junction box for better cable arrangement

Dimension:

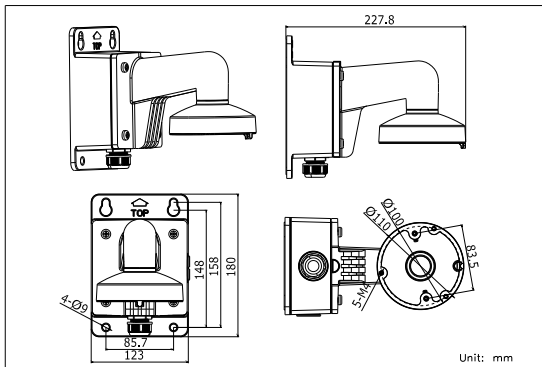

Order Model:

DS-1272ZJ-110B

Parameter:

Model	DS-1272ZJ-110B
Parameters	Wall Mounting Bracket for Dome Camera (with Junction Box)
Appearance	Hikvision White
Range of Application	Dome camera wall mounting
Material	Aluminum Alloy
Dimension	123×180×227.8mm
Weight	1205g

Notice:

- Pay attention to the color matching when select bracket
- The bracket should be installed on flat wall
- The wall must be capable of supporting over 3 times as much as the total weight of the camera and the mount.
- The maximum load capacity of the bracket is **4.5KG**

Model Suitable:

DS-2CC51D3S-VPIR, DS-2CC52D5S-VPIR, DS-2CD2112(D)-(I), DS-2CD2132(D)-(I)

Installation Step:

- ① Choose the appropriate wall to fix the junction box

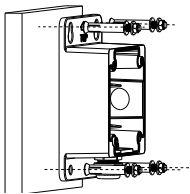

- ② Thread cable through waterproof stopper

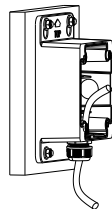

- ③ Install bracket to junction box; thread the cable and screw up

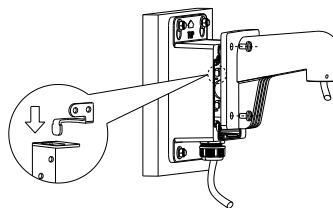

- ④ Screw adaptor cap to bracket and fix with fastening screw; thread the cable

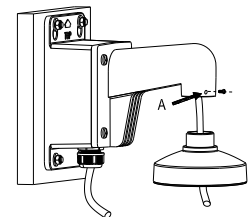

A: Fastening screw

- ⑤ Take off lower dome and inner dome module

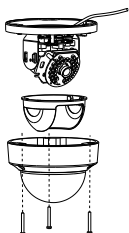

- ⑥ Thread the cable and fix module to adaptor cap

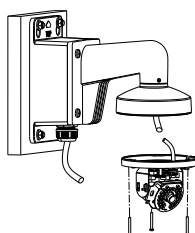

- ⑦ Adjust the angle of view; install lower dome and screw up

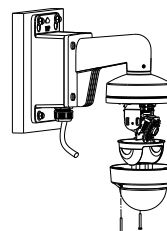

- ⑧ Installation complete

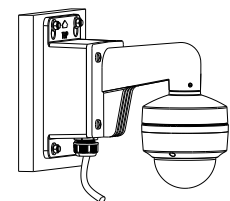

Note: The actual bracket may vary from the picture above.