

IR Illuminator HL90IR14



Features

- Die casting aluminum housing, strong and durable
- Support brightness adjustment
- Support light sensor sensitivity adjustment
- IR pass panel, delicate and covert
- IP66 waterproof
- 1years warranty

Technical Specification

LED type: 5 pieces high power 1W IR LED
 Wavelength: 850nm
 Beam angle: 90°
 Beam distance: 14m
 Bracket: wall mount bracket
 Working voltage: AC110-220V
 Power consumption: <7W
 Cable length: 130cm (4.27ft)
 Day/night switch: automatic (built-in photocell)
 0-50LUX adjustable
 Brightness adjust: 5%-100% adjustable
 Working temperatures: -20°C to 50°C
 Protection level: IP66
 Color: white
 Panel: tempered glass + IR passing panel
 Housing: aluminum die-casting housing
 Net weight: 0.7kg
 Gross weight: 0.8kg

Model for Selection

Model	Beam angle	IR distance (850nm)
HL90IR14	90°	14m

*Viewing distance is tested by 1/3" Sony CCD camera with 0.01LUX.

To achieve the distance needed, please pay attention to your camera specification and lens before purchase. It is normal phenomenon that distance may vary due to different cameras and lens.

Viewing picture at night



With IR light



Without IR light

Drawing

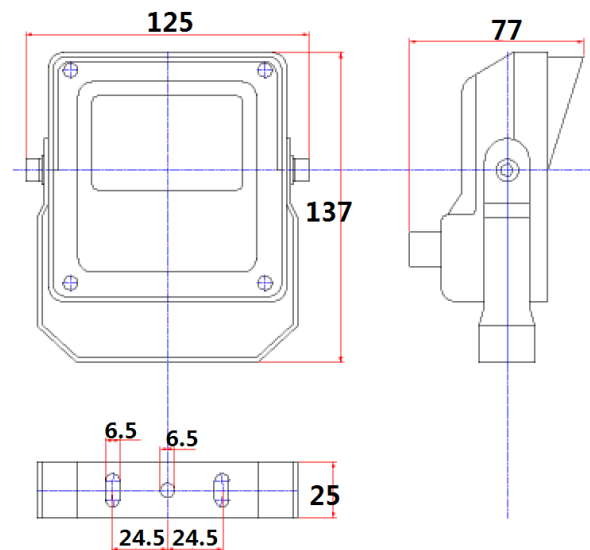

Unit: mm

Product Certificate

