

Warranty

▶ **To receive after service, have the following ready before you contact our branches.**

1. Name of the product.
2. Model number of the product.
3. The area of problem.
4. Phone number and address at which you can be contacted.

Warranty Card

<b>PRODUCT</b>	
<b>MODEL</b>	
<b>DATE PURCHASED</b>	
<b>WARRANTY PERIOD</b>	
<b>AGENCY ADDRESS</b>	

▶ **KOCOM Warranties the original purchaser of this product as follows.**

- 1) This product is produced under strict quality control and inspection procedures.
- 2) If this product breaks down during proper use as a result of product defect, KOCOM will repair it within one year from date of purchase free of charge.
- 3) The following cases will be subject to charge, even during warranty period:
  - a. Breakdown during transport, or through careless treatment, by consumer.
  - b. Breakdown cause by unauthorized repair, or system modification.
  - c. Breakdown caused by natural disaster or power disorder.



<http://www.kocom.com>

E-mail : [export@kocom.co.kr](mailto:export@kocom.co.kr)

This manual is based on the date as shown in the right and specifications are subject to change without notice for quality improvement

# KLP-420 series MANUAL

[ 4-Wire Common Lobby Phone Operation/Installation Manual ]

## Digital bus type multiple system 4-Wire common gate lobbyphone

- Stylish design with Touch button keypad
- Keypad Backlight on automatically at night
- Up to 450 Houses connection
- Easy to install only with 4 wires of BUS system (in & out)
- Audio & Video Conversation with Visitor
- Door Open & Monitoring available
- Door open Function by Access Code or by RF card (\*KLP-C420RF)
- White LED on to help a user to identify the visitor well at night
- Extension the same Lobbyphone up to 4 units
- Camera Angle adjustable



# Cautions for safety

For safe use, please stick to the following cautions.







- Please, save this manual after reading these instructions carefully.
- Read and understand all instructions to set up rightly.
- This Cautions for Safety may include items that are not contained in specifications of the product that consumer purchases.
- If you need assistance with the set-up or operation, please contact with A/S center.

## The important marks in the manual.

To help our customers to understand this manual, to prevent any personal injury or property damage, some marks are used in the manual.

The marks and the drawing signs are below. Please, understand the marks before reading the manual.

## The meaning of the drawing signs.

 Sign to show what not to do	 Mishandling the device with ignoring this sign may result in serious injury or death.
 Mishandling the device with ignoring this sign may result physical injury or material damage.	
 Sign to tell you that you should follow the instructions.	 Sing to tell you that you need more attention including high voltages, electric shock, danger, warning)
 Sign to tell you that you can't disassemble this unit.	 Sign to tell you that you must unplug the unit.

## Caution

### Caution for set-up

- The law limits distributing the power lines to an authorized person from government. The work from an unauthorized person cause fire or electric shock.
- Place this unit securely on a stable surface. Serious damage and/or injury may result if the unit falls.
- Do not set up this unit near the leaking place because it may expose you to dangerous voltages or other risks.
- Even if your product is water proof, do not install it slanted place of water leakage, which can a short circuit.
- The work of distributing wires needs skills and experiences. So please, for assistance, contact your dealer or call service center.
- The communication lines should be built in being distant from the power source. This may result in the risk of fire, electric shock and communication disorder.
- Setting the communication lines in a high humid place such as outside without any protection from rain causes the communication disorder.
- Keep the hook at the wall-mounted device safe. The hook may cause the physical injury.
- Think about the thickness and quality of wall material. The unqualified material may make the device fall.
- Set the device of the wall-mounted type not to fall. Falling from an earthquake causes personal injury.

### Caution for Repairs and Maintenance

- Keep the inside of the device clean. Having the dust inside without any cleaning for a long time causes the fire. If necessary, contact your dealer or service center to get cleaning service.
- Unplug this device when you want to check the inside. If there is no plug, please, turn off the circuit breaker.
- Unplug this device when you try to move it to another place. If the electric line is connected inside of the unit, please contact your dealer or service center.
- Do not use liquid or aerosol cleaners. Use a damp cloth for cleaning

## Warning

### Warnings for Usage

- Do not install this unit near the water and dust, for example, in a bathroom or near the washing machine. It caused fire and electric shock.
- Do not install this unit near the fire, for example, near kitchen sink, heater or the like.
- Do not install near the noxious gas such as Hydrogen Sulfide, metal power and the like.
- Do not install near the water and chemicals.
- Do not give any damage, break and modify the plug. Overloading, heating, pulling causes the damage.
- Do not place the plug near the heater. The damaged code causes fire and electric shock. Do not pull the power code when unplugging.
- The damaged code causes fire and electric shock. Must pull with plug. Do not touch with wet hands. It causes the electric shock.
- Do not use any other voltage, except the marked regular voltage.
- Do not use the power terminal at the units to other electric device except the designed device.
- Do not install the units at the leaking place if it doesn't have any waterproof mark. Do not install the unit when the power is on.
- Install the circuit breaker after checking the safety such as electric shock and leakage. Turn off the power before you install or A/S
- Check the suitability of the lines for installing when you use the exiting lines.
- Do the wiring work by using the designed material.
- Connect the electric wire with the designed ways and ground.
- Do not connect with any other devices except the designed devices to compose the system.
- Unplug electric wire and communication lines from the units before moving to another place.

### Caution for Use

- This unit is not designed for security purpose.
- Do not handle the unit with the wet hands.
- Do not place a pot with water or a small metal material on the Units.
- Do not cover the ventilating opening or put any metal material in the units.
- During thunderstorms, avoid using this unit. There may be a remote risk of an electric shock from lightning.
- Do not modify the unit.
- Open the main gate after checking ID if the image and sound system do not work. Call A/S

### Caution for Abnormality

- Change the damaged electric code.
- Unplug this unit from plug socket and refer servicing to an authorized service center when the following conditions occur:
  - If liquid has been spilled into the unit.
  - If the unit does not work normally by following the operating instructions.
  - If the unit exhibits a distinct change in performance.
  - If the unit has been dropped or physically damaged.

## Caution

### Safety Instructions, Warnings and Cautions of Each System

- Do not disassemble this unit at will as this device is composed by precision parts.
- Install the unit by following the set-up instructions of Kocom.
- Do not touch or insert any foreign substances, for example, sticker, magnetic, opener and the like
- Make U-type at the end of wires as the rain can effect on the system by following the wires during the rainy season.

### Videophone

- Separate the AC/DC lines with the hook of the wall-mounted type when installing.
- Connect the lines after peeling the wires properly
- Do not distribute signal line with AC line.
- Use the designed driver to connect the lines to terminal
- Do not clean the LCD with the damp cloth for cleaning. Use the only dry and soft cloth.
- Do not install the main gate monitor at the leaking place.

### Things You Need to Know

- This product is designed as a home videophone and cannot use continuously like monitor camera.
- If there is temperature difference between inner part of camera and surrounding, dew condensation occurs on camera lens and may disturb image. If dew condensation is removed from camera lens, image quality recovers.
- White LED light examination range is narrower than camera shot range at night, so there is less amount of light at night than day. So it is difficult to see the face in low illumination condition due to noise increase on screen, but it is not from defect.
- Monitor screen (liquid crystal panel) is not in defect when some pixels always light or black out.
- Please install monitor and camera over 5cm away. Also, avoid installing at a place with too much noise, because too much noise around camera causes phone call inferiority.
- Do not place an object within 20cm in front of monitor. It causes phone call inferiority, especially because microphone is installed at the top of monitor.
- If strong light such as sunlight flows into camera module, screen saturation (or strange mark) and image shaking might occur.
- This is not a defect, so please do not install camera where a direct ray of light do not flow if possible.

### Cautions

- In some cases there is occurrence of product destruction, malfunction, noise mixing and picture quality deterioration due to mixing of other tool's induced voltage or thunder with communication wiring of monitor/camera, monitor/extended monitor.
- Do not wire with power line such as outdoor wiring or AC power, or phones and other tools.
- You cannot use it if you incorrectly wire the AC voltage between monitor/camera, monitor/extended monitor. Call the store or agency where you purchased this product and consult to solve the problem.
- Beware that unfixable damage might be caused due to authorizing AC voltage on communication wiring of monitor/camera, monitor/extended monitor.
- Do not ever disjoint this product. It may cause electrocution accident when touching high-voltage circuit inside this product.
- Outside power authorizing this product must be confirmed of product description and use rated voltage. Beware that if higher voltage is authorized, unfixable damage might be caused due to product destruction.
- Power must be connected to domestic voltage (product rated voltage) consent or interior wiring. If connected to other motive power or inverter-type power, product destruction, noise mixing, and picture distortion may occur.
- Do not drop this product. Glass is used for monitor and might break, or cause other circuit inferiority.
- In such case, immediately turn down the power switch, and call to consult agency or store in which this product was purchased.
- If installed near transmission antenna such as broadcasting station, electric wave may mix and cause picture distortion or voice mixing.
- Avoid installing near tools with strong electromagnetic waves such as microwaves and cell phones, or it may cause picture distortion.
- Do not install monitor in following places.
  - ① Above or around water heater, rice-cooker, heater
  - ② Place exposed to direct rays of the sun
  - ③ Place with temperature below 0°C such as cold store
  - ④ Place with high humidity such as bathroom, washroom, heated room
  - ⑤ Place with a lot of gas, dust, smoke
  - ⑥ Dangerous place with sprays of water or chemicals
- Do not wipe with insecticide, drugs or chemicals such as thinner and alcohol, or it may damage the surface of this product.
- Beware of occurrence of image quality deterioration or malfunction from cause of humidity due to penetration of chemicals or water into camera's urea resins.
- As in the picture, it prevents temperature difference of camera (outside) and monitor (inside), and removes dew condensation caused by humidity of camera window.
- Camera must be installed when wall cement is completely dry.
- When product is installed in winter below -5°C, wait for approximately 2 hours to connect. Dew formation in monitor and camera due to temperature difference inside and outside may cause product defect.
- Avoid installing monitor and camera in place directly exposed to heat or where gas noxiousness is highly occurring.

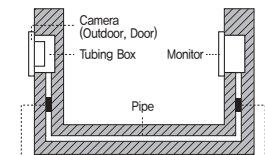

Stop up P.V.C pipe using adiabatic substances, to prevent air circulation

## Precautions for Operation

- Keep away from humidifier and stove.
- High temperature and humidity may cause troubles.
- Do not drop this device and avoid strong impact.
- Keep away from devices generating strong magnetic field (TV, Speaker, etc.)  
(Images can be distorted or blurred as well as mechanical troubles may be caused.)
- When cleaning, do not use wet hand, volatile benzene or paint thinner.
- Keep image clear by cleaning camera window frequently with soft cloths.
- As this device consists of electronic precision components, do not attempt to disassemble.

## Wiring Specifications

※ A wire length is the maximum distance from a Lobby Phone to a Wall Pad.

### ■ Up to 150M : CAT5 Cable

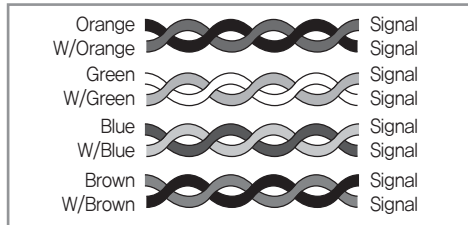

### ■ Up to 300M : CAT5 Cable

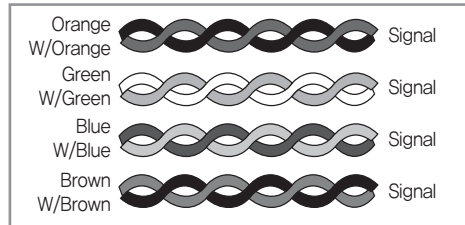

- Above wire length is the maximum line distance, and the longer a line distance, the lower voice and image quality.
- The specifications of line distance can be modified by wiring connection and installation environment.

## Component's name

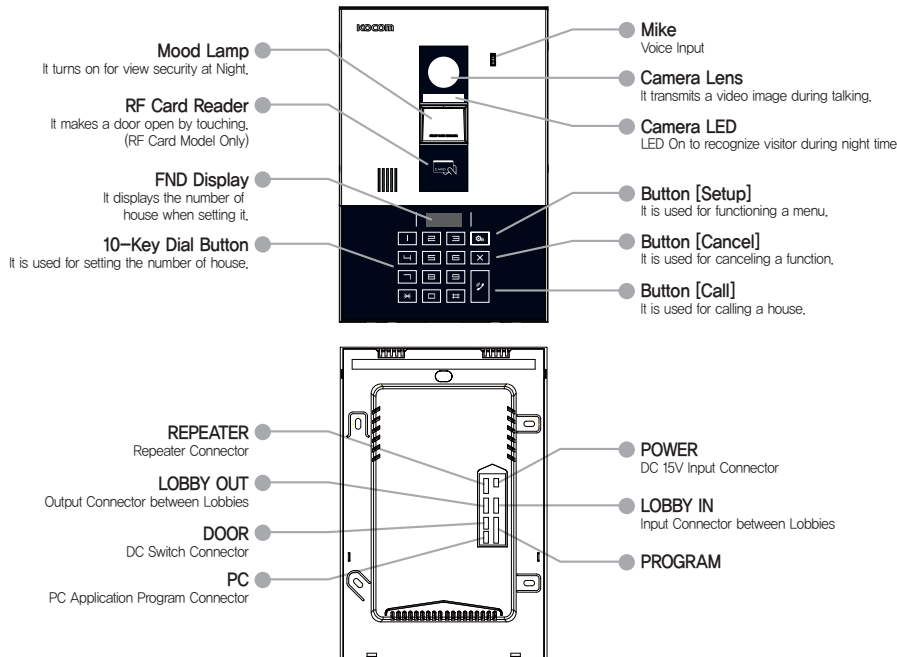

## Components

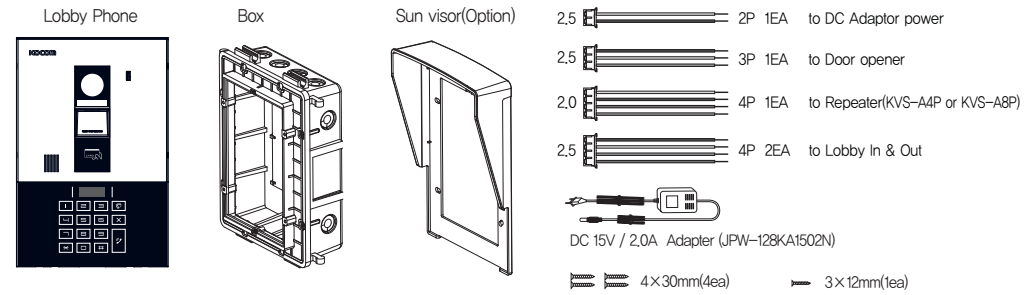

## Specifications

Model NO.	KLP-C420	KLP-C420R
Input Power	DC 15V±1V	DC 15V±1V
	ON STAND BY : 2W and below	ON STAND BY : 3W and below
	FULL LOAD only KLP-C420 : 6W and below	FULL LOAD only KLP-C420R : 7W and below
	FULL LOAD KVS-A4P or KVS-A8P : 12W and below	FULL LOAD KVS-A4P or KVS-A8P : 13W and below
Lobby Phone Data Mode	KOCOM PROTOCOL DATA TX/RX Mode	
Speak Mode	Hands-free Speak Mode	
Timer	Call Duratin Time : 180 seconds (Call Waiting Time depends on a wall pad interlocked.)	
Housing Material	Aluminium (A/L), PC, ABS	
Size	(W)174 × (H)263 × (D)15 (mm)	
Guaranteed Operation Temperature	-10°C ~ +50°C	
LED Lighting Functions	10KEY LED : It turns on when operating a key.	
	Mode-Lamp LED : It turns on below a certain illuminance.	
	Camera LED : It turns on when calling a house at a low illuminance.	
Angle of View	It controls an angle at a direction of up, down, right and left.	
RF Card Interlocking	N/A	13.56MHz
Monitor Connection	B/W : KVM-301, KVM-D301, KVM-340 Color : KCV-301, KCV-340, KCV-A374/D374/A374SD/D374SD, KVR-A510/D510	

## Installation

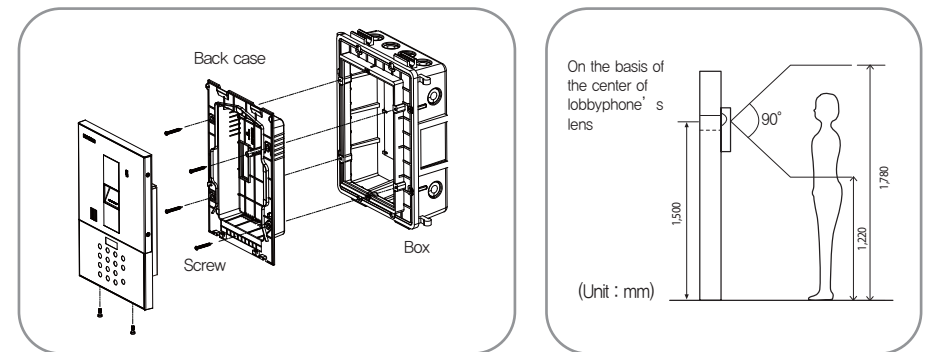

### ■ Standard height for installation of Lobbyphone

Standard installation height of lobbyphone is 1,400~1,450mm from floor to the bottom of flush mounting box. In case that the installation height of lobbyphone is out of the range (min.1,250mm~1,550mm), it's hard to get proper image, so be careful about the installation height of lobbyphone.

▷House Call and Speak

- To connect with a house, press the number of house and a button [Call] in order.
- To speak with a visitor, press a button [SPEAK] on a wall pad of the house.
- To cancel calling and speaking, press a button [\*] or [Cancel].
- A speaking duration is 180 seconds, and the waiting time of call depends on the monitor interlocked.

EX) To call house number 101



EX) To cancel call and speak with house number 101



▷Door Unlock by a Common Password

- If a user presses a button [#] under standby mode, FND displays [----].
- If a user presses the common password saved and a button [#] in order at this time, a door opens.

EX) To unlock a door by a common password



▷Registration of House Password

- If a user presses a button [#] during speaking with a wall pad to register a house password, FND displays [----].
- A user inputs a former password and presses a button [#]. If the former password is correct, FND displays [----]. But, if the former password is wrong, the function 'Password Register' becomes terminate by force.  
(Only, a user has no any former password, he/she can use "9999" as a former password.)
- If a user registers a new password and then presses a button [#], FND displays [ P. Y E S. ] and a password is newly changed and registered.

EX) To change the password of house no. 101 to "1234"

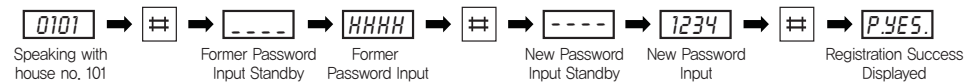

▷Door Unlock by a Common Password

- If a user presses a house no. and a button [#] in order under standby mode, FND displays [----].
- If a user presses the house password saved and a button [#] in order at this time, a door opens.

EX) To unlock a door by a house password

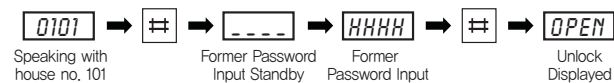

▷Door Unlock by RF Card

- This function is applied to KLP-C420R only. If a user accesses RF Card to the reader registered, a door opens.

※ A user should use this product just after completing the setup on a Lobby Phone.

▷How to set up Menu

- If a user presses a button [SET] under standby mode, FND displays [----] to input a system password after [ M E n u ] display is flickered for 2 seconds.
- If a user inputs a system password and a button [#] in order, the menu to set up a system password is displayed.



▷How to display Menu and move between Menus

- Whenever a user presses a button [SET] after entering into a menu, a menu is displayed in the below order.
- If a user wants to move to one menu among main Menu ①~⑩, press the key number of 10-key buttons on a lobby phone.  
(only, press a button [0] to move to menu ⑩.)

- ① *Lb.PS.* System Password Setup
- ② *9E.PS.* Common Password Setup
- ③ *r.F.Id.* RF-CARD Register
- ④ *C.dEL.* HOUSE RF-CARD Delete
- ⑤ *R.dEL.* RF-CARD All Delete
- ⑥ *bldg.* Lobby Phone Building No. Setup
- ⑦ *Lb.Id.* Lobby Phone ID Setup
- ⑧ *RL.Id.* House No. All Delete
- ⑨ *5d.Id.* House No. Register
- ⑩ *dP.PS.* House Password View
- ⑪ *dr-t* Common Gate Unlock On-Time Setup

▷System Password Setup

- Select a menu for [System Password Setup] after entering into a menu.
- If a user presses a button [Cancel], the former password is flickered 2 times and then FND displays [----].
- If a user inputs a new system password of 4 digits and then presses a button [#], a new password is flickered 2 times and then the setup is completed.
- Next, a menu display enters into the menu for "Common Password Setup" after completing the setup of a system password.
- To terminate menu setup at this time, press a button [\*] or [Cancel].

EX) To change the former system password "1234" to a new system password "8282"

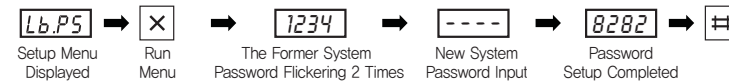

▷Common Password Setup

- If a user presses a button [Cancel], the former common password is flickered 2 times and then FND displays [----].
- If a user inputs a new common password of 4 digits and then presses a button [#], a new password is flickered 2 times and then the setup is completed.
- Next, a menu display enters into the menu for "RF-Card Register" after completing the setup of a common password.
- To terminate menu setup at this time, press a button [\*] or [Cancel].

EX) To change the former common password "1234" to a new common password "8282"

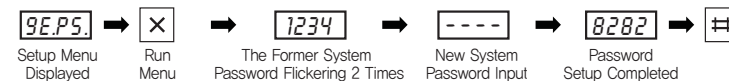

## How to Setup

### ▷RF-CARD Register

- This function can be applied to KLP-C420R only.
- If a user presses a button [Cancel] after entering into this menu, the standby mode to input a house number is flickered as FND [ S d . l d . ] and then FND [ \_ \_ \_ \_ ] to input a house number displays.
- If a user inputs a house number to register RF-Card and then presses a button [#], FND [ C a r d ] displays.
- If a user touches RF-Card to the reader when FND [ C a r d ] displays, the RF-Card is registered.
- If the registration is completed, FND [ ( ( ) ) ] displays, and after a while, FND [ C a r d ] displays again so that a user can register several RF-Cards per house.
- If a certain time (about 15 seconds) passes, the screen automatically returns to the menu for "RF-Card Register" .
- To terminate menu setup at this time, press a button [\*] or [Cancel].
- Maximum 1000 RF-Cards can be registered regardless of the number of houses.

EX) To register RF-Card at the house with a house number "1004"

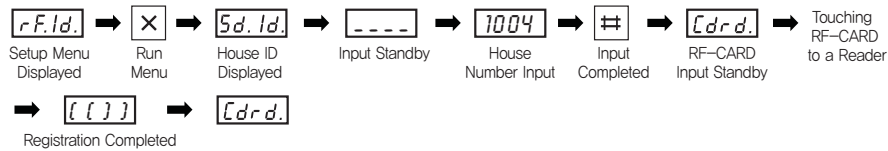

### ▷HOUSE RF-CARD Delete

- This function can be applied to KLP-C420R only.
- If a user presses a button [Cancel] after entering into this menu, the standby mode to input a house number is flickered as FND [ S d . l d . ] and then FND [ \_ \_ \_ \_ ] to input a house number displays.
- If a user inputs a house number to delete RF-Card and then presses a button [#], FND [ C . d E L . ] displays.
- It deletes RF-Card Data for the house number after passing some time.
- If the RF-Card is completely deleted, FND [ ( ( ) ) ] flickers and then again FND [ \_ \_ \_ \_ ] to input the house number for RF-Card deletion displays. Under this status, a user can delete another RF-Card in accordance with above orders.
- To terminate menu setup at this time, press a button [\*] or [Cancel].

EX) To delete RF-Card at the house with a house number "1004"

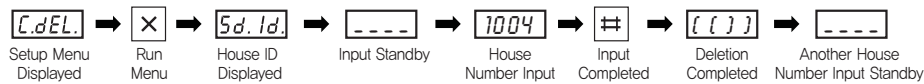

### ▷RF-CARD All Delete

- This function shall be applied to KLP-C420R only.
- If a user presses a button [Cancel] after entering into this menu, FND [ d E L . ? ] displays.
- If a user presses a button [#] at this time, the count-up for FND [ d . 0 0 1 ] to [ d . 4 7 0 ] is completed, FND [ ( ( ) ) ] displays and then the screen returns to the menu of FND [ A . d E L . ]
- To terminate menu setup at this time, press a button [\*] or [Cancel].

EX) To delete all RF-Cards registered



## How to Setup

### ▷Lobby Phone Building No. Setup

- If a user presses a button [Cancel] after entering into this menu, the former building number [ 0 0 0 1 ] flickers for 2 seconds on FND.
- FND [ \_ \_ \_ \_ ] which is able to input a Lobby Phone building number plays.
- If a user inputs a new lobby phone building number and then presses a button [#], the new lobby phone building number flickers for 2 seconds and then the new setup is completed.
- The screen returns to the menu for "Lobby Phone ID Setup" after completing the new setup.
- To terminate menu setup at this time, press a button [\*] or [Cancel].

EX) To change Lobby Phone Building No. "0001" to "0102"

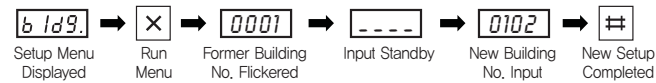

### ▷Lobby Phone ID Setup

- If a user presses a button [Cancel] after entering into this menu, the former lobby phone ID [ L b . 0 2 ] flickers for 2 seconds on FND.
- FND [ L b . -- ] displays to input a Lobby Phone ID.
- If a user inputs a new lobby phone ID and then presses a button [#], the new lobby phone ID flickers for 2 seconds and then the new setup is completed.
- The screen returns to the menu for "House No. All Delete" after completing the new setup.
- To terminate menu setup at this time, press a button [\*] or [Cancel].

EX) To change Lobby Phone ID "1" to "2"

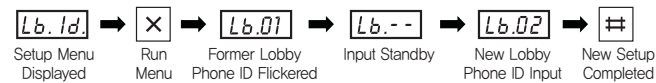

### ▷House No. All Delete

- If a user presses a button [Cancel] after entering into this menu, FND [ d E L . ? ] displays.
- If a user presses a button [#] at this time, all house numbers registered are deleted.
- If all house numbers are completely deleted, FND [ ( ( ) ) ] displays. And the screen returns to the menu for "House No. Register" .
- To terminate menu setup at this time, press a button [\*] or [Cancel].

EX) To delete all house numbers registered



### ▷House No. Register

※ To call a house, surely map a house number as below.

- A mapping number is decided by the DIP switch state of a repeater and a wall pad connected with a repeater.
- If a user presses a button [Cancel] after entering into this menu, FND [ \_ \_ \_ \_ ] which is the standby mode to input a house number displays.
- If a user inputs a house number and then presses a button [#], FND [ n . -- ] which is the standby mode to input a mapping number displays.
- If a user inputs a mapping number "0001" ~ "638" and then presses a button [#], the house number is registered.
- Only, the figure of "1" ~ "8" can be used for the last digit of a mapping number (the digit of '1' ).
- In succession, FND [ \_ \_ \_ \_ ] displays so that it is able to register a house number.
- To terminate menu setup at this time, press a button [\*] or [Cancel].

EX) To register Mapping No. 1 as a house number "1004"

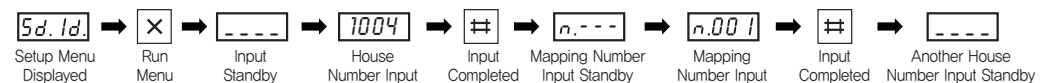

## How to Setup

### ▷ House Password View

- If a user presses a button [Cancel] after entering into this menu, FND [ S d. l d. ] which is the standby mode to input a house number flickers.
- FND [ \_ \_ \_ \_ ] which is able to input a house number displays after flickering FND [ S d. l d. ].
- If a user inputs a house number and then presses a button [#], the house password flickers on FND.
- FND [d P. P S. ] which is a menu for "house password view" displays again after flickering the password.
- To terminate menu setup at this time, press a button [\*] or [Cancel].

EX) To check a house password registered at the house with a house number "1004"

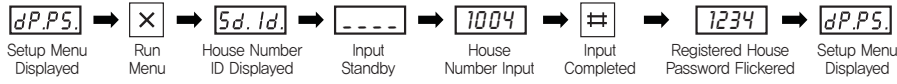

### ▷ Common Gate Unlock On-Time Setup

- If a user presses a button [Cancel] after entering into this menu, FND [ t - 0 2 ] which is the current setup value displays.
- If a user presses a time to change among [1] to [8] and a button [#] in order after flickering FND, the door unlock on-time registered flickers and setup is completed. A unit of time is 'sec..
- To terminate menu setup at this time, press a button [\*] or [Cancel].

EX) To change 'door unlock on-time' from '2 seconds' to '7 seconds'

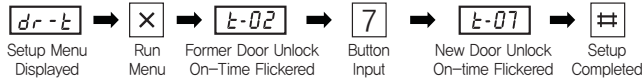

### ▷ Special Functions

- Factory Reset Password : 1 2 3 5 8 0 0
- System Password Check : 1 3 7 9 5 0

## Total Scenarios

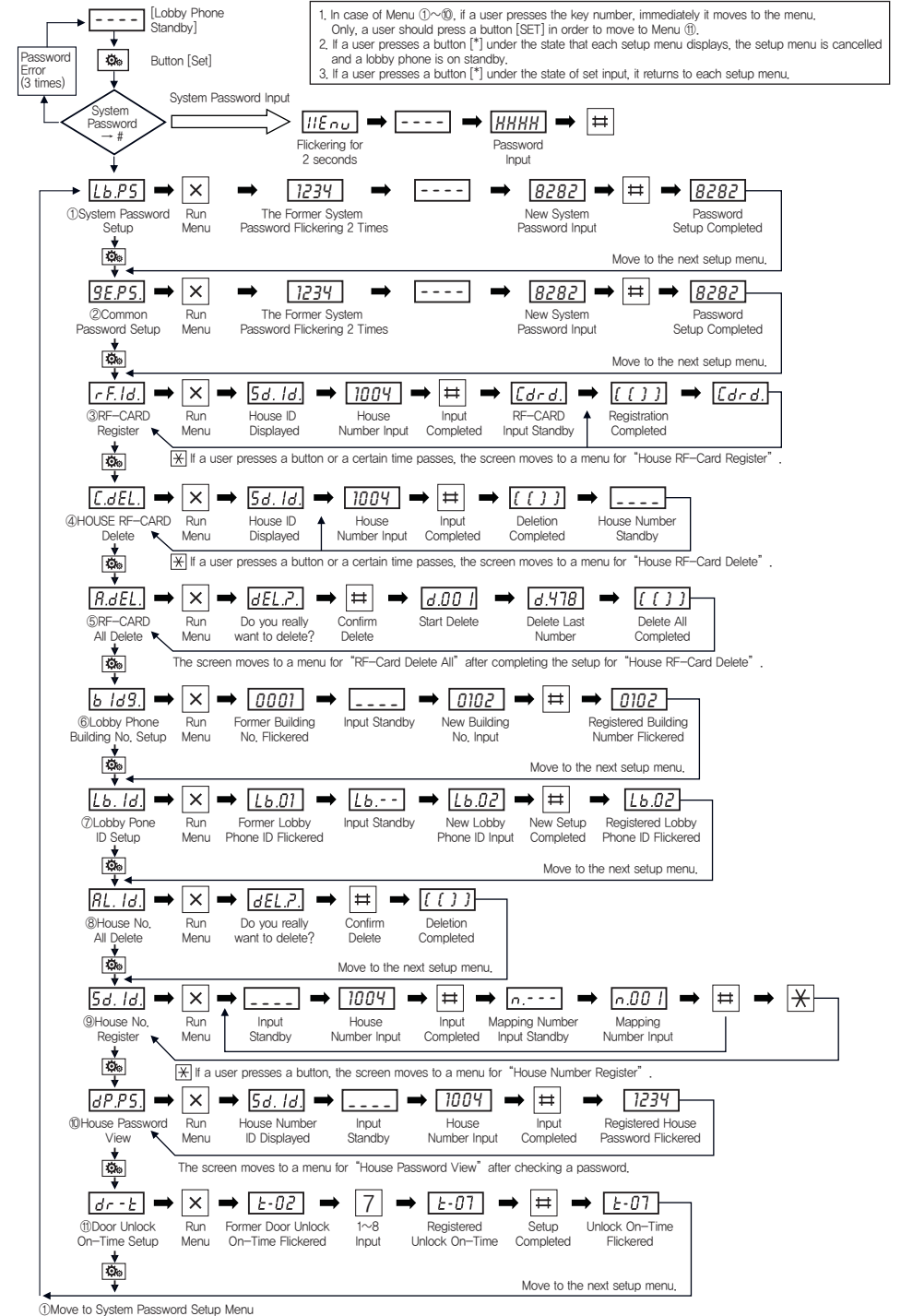

## Specifications of Lobby Phone Terminal

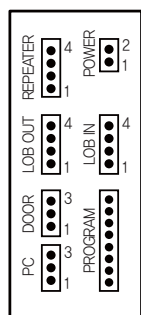
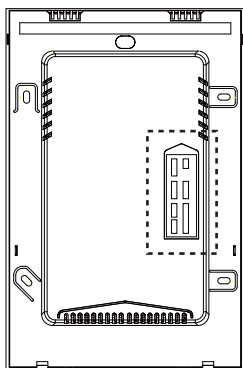

REPEATER : Repeater Connector  
1. VCC  
2. GND  
3. AUDIO  
4. VIDEO

POWER : Adapter Connector  
1. DC +15V  
2. GND

LOB IN : Input Connector to connect with Lobby Phone

LOB OUT : Output Connector to connect with Lobby Phone

1. DATA  
2. GND  
3. AUDIO OUT  
4. VIDEO OUT

PROGRAM : Program Wiring

DOOR : DC Switch Connector

1. N/O  
2. COMMON  
3. N/C

PC : PC Application Program Connector

1. VCC  
2. GND  
3. DATA

## Wiring Specifications

■ Wiring Diagram between Lobby Phones

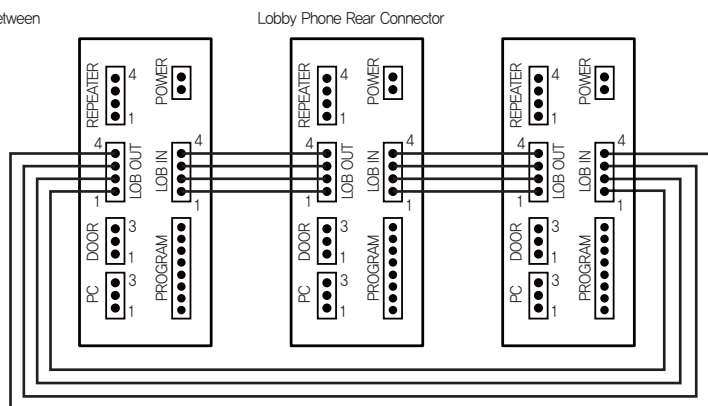

■ Wiring Diagram of Lobby Phone and Repeater

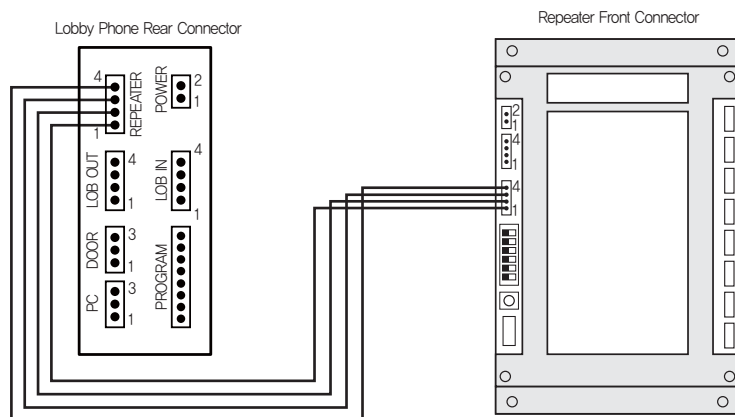

## Wiring Diagram

■ Overall Wiring Diagram

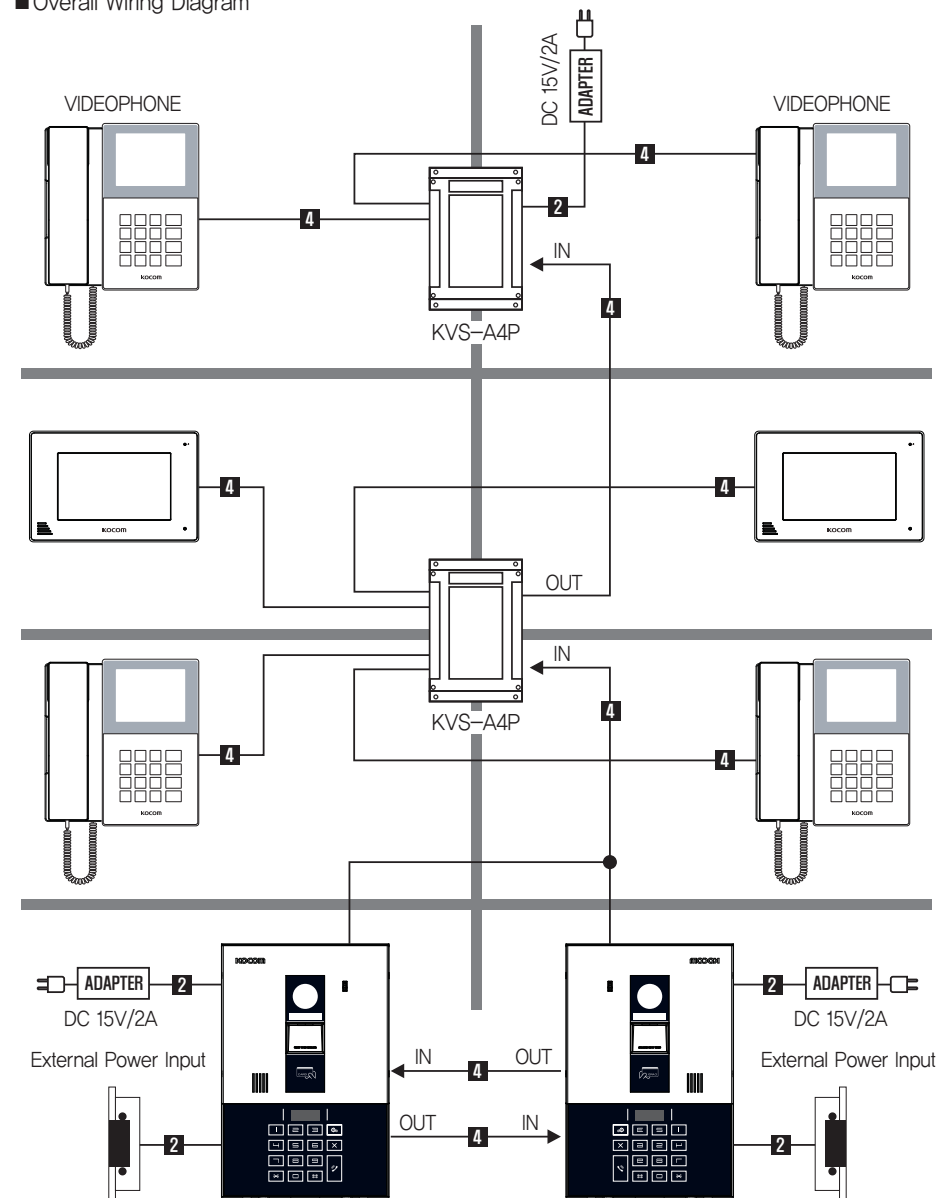

- ※ Max. Extension of Lobby Phone KLP-C420 or KLP-C420R is 4 units.
- ※ Max. Extension of Repeater KVS-A4P or KVS-A8P is 60 units.
- ※ 1 Adaptor per 1 Lobby Phone is recommended, But only when the distance between 2 Lobby Phones is within 10m, 1 adaptor can be used for the both 2 Lobby Phones.
- ※ Only KOCOM 4 wire monitors are compatible, to check model names please refer to 'Monitor Connection' on pag. 5.
- ※ As shown on the above diagram, with KVS-A4P, 4 monitors can be connected to the repeater and with KVS-A8P, 8 monitors are possible to connect.

