

10inch touch quad  
**DVR VIDEOPHONE**



KVR-A510/D510

# Cautions for safety

For safe use, please stick to the following cautions.

- Please, save this manual after reading these instructions carefully.
- Read and understand all instructions to set up rightly.
- This Cautions for Safety may include items that are not contained in specifications of the product that consumer purchases.
- If you need assistance with the set-up or operation, please contact with A/S center.

## The important marks in the manual.

To help our customers to understand this manual, to prevent any personal injury or property damage, some marks are used in the manual. The marks and the drawing signs are below. Please, understand the marks before reading the manual.

## The meaning of the drawing signs.

	Sign to show what not to do
	Mishandling the device with ignoring this sign may result physical injury or material damage.
	Sign to tell you that you should follow the instructions.
	Sign to tell you that you need more attention including high voltages, electric shock, danger, warning
	Sign to tell you that you can't disassemble this unit.
	Sign to tell you that you must unplug the unit.

## Caution

- **Cautions for set-up**
  - The law limits distributing the power lines to an authorized person from government. The work from an unauthorized person cause fire or electric shock.
  - Place this unit securely on a stable surface. Serious damage and/or injury may result if the unit falls.
  - Do not set up this unit near the leaking place because it may expose you to dangerous voltages or other risks.
  - Even if your product is water proof, do not install it slanted place of water leakage, which can a short circuit.
  - The work of distributing wires needs skills and experiences. So, please, for assistance, contact your dealer or call service center.
  - The communication lines should be built in being distant from the power source. This may result in the risk of fire, electric shock and communication disorder.
  - Setting the communication lines in a high humid place such as outside without any protection from rain causes the communication disorder.
  - Keep the hook at the wall-mounted device safe. The hook may cause the physical injury.
  - Think about the thickness and quality of wall material. The unqualified material may make the device fall.
  - Set the device of the wall-mounted type not to fall. Falling from an earthquake causes personal injury.
- **Cautions for Repairs and Maintenance**
  - Keep the inside of the device clean. Having the dust inside without any cleaning for a long time causes the fire. If necessary, contact your dealer or service center to get cleaning service.
  - Unplug this device when you want to check the inside. If there is no plug, please, turn off the circuit breaker.
  - Unplug this device when you try to move it to another place. If the electric line is connected inside of the unit, please contact your dealer or service center.
  - Do not use liquid or aerosol cleaners. Use a damp cloth for cleaning
  - Danger of explosion if battery is incorrectly replaced. Replace only with the same or equivalent type.

## Warnings for Usage

- Do not install this unit near the water and dust, for example, in a bathroom or near the washing machine. It caused fire and electric shock.
- Do not install this unit near the fire, for example, near kitchen sink, heater or the like.
- Do not install near the noxious gas such as Hydrogen Sulfide, metal power and the like.
- Do not install near the water and chemicals.
- Do not give any damage, break and modify the plug. Overloading, heating, pulling causes the damage.
- Do not place the plug near the heater. The damaged code causes fire and electric shock. Do not pull the power code when unplugging.
- The damaged code causes fire and electric shock. Must pull with plug. Do not touch with wet hands. It causes the electric shock.
- Do not use any other voltage, except the marked regular voltage.
- Do not use the power terminal at the units to other electric device except the designed device.
- Do not install the units at the leaking place if it doesn't have any waterproof mark. Do not install the unit when the power is on.
- Install the circuit breaker after checking the safety such as electric shock and leakage. Turn off the power before you install or A/S
- Check the suitability of the lines for installing when you use the exiting lines.
- Do the wiring work by using the designed material.
- Connect the electric wire with the designed ways and ground.
- Do not connect with any other devices except the designed devices to compose the system.
- Unplug electric wire and communication lines from the units before moving to another place.

## Cautions for Use

- This unit is not designed for security purpose.
  - Do not handle the unit with the wet hands.
- Do not place a pot with water or a small metal material on the Units.
- Do not cover the ventilating opening or put any metal material in the units.
- During thunderstorms, avoid using this unit. There may be a remote risk of an electric shock from lightning.
- Do not modify the unit.
  - Open the main gate after checking ID if the image and sound system do not work. Call A/S
- Do not disassemble the back and cabinet cover.

## Cautions for Abnormality

- Change the damaged electric code.
- Unplug this unit from plug socket and refer servicing to an authorized service center when the following conditions occur:
  - If the unit does not work normally by following the operating instructions.
  - If the unit has been spoiled into the unit.
  - If the unit exhibits a distinct change in performance.
  - If the unit has been dropped or physically damaged.
- To prevent injury, this apparatus must be securely attached to the floor/wall in accordance with the installation instructions.

## Caution

### Safety Instructions, Warnings and Cautions of Each System

- Do not disassemble this unit at will as this device is composed by precision parts.
  - Install the unit by following the set-up instructions of Kocom.
- Do not touch or insert any foreign substances, for example, sticker, magnetic, opener and the like
- Make U-type at the end of wires as the rain can effect on the system by following the wires during the rainy season.

### Video phone

- Separate the AC/DC lines with the hook of the wall-mounted type when installing.
  - Connect the lines after peeling the wires properly
- Do not distribute signal line with AC line.
  - Use the designed driver to connect the lines to terminal
- Do not clean the LCD with the damp cloth for cleaning. Use the only dry and soft cloth.
  - Do not install the main gate monitor at the leaking place.

### Things You Need to Know

- This product is designed as a home videophone and cannot use continuously like monitor camera.
- If there is temperature difference between inner part of camera and surrounding, dew condensation occurs on camera lens and may disturb image.
- Dew condensation is removed from camera lens, image quality recovers.
- White LED light examination range is narrower than camera shot range at night, so there is less amount of light at night than day. So it is difficult to see the face in low illumination condition due to noise increase on screen, but it is not from defect.
- Monitor screen (liquid crystal panel) is not in defect when some pixels always light or black out.
- Please install monitor and camera over 5cm away. Also, avoid installing at a place with too much noise, because too much noise around camera causes phone call inferiority.
- Do not place an object within 20cm in front of monitor. It causes phone call inferiority, especially because microphone is installed at the top of monitor.
- If strong light such as sunlight flows into camera module, screen saturation (or strange mark) and image shaking might occur.
- This is not a defect, so please do not install camera where a direct ray of light do not flow if possible.

### Cautions

- In some cases there is occurrence of product destruction, malfunction, noise mixing and picture quality deterioration due to mixing of other tool's induced voltage or thunder with communication wiring of monitor/camera, monitor/extended monitor.
  - Do not wire with power line such as outdoor wiring or AC power, or phones and other tools.
  - You cannot use it if you incorrectly wire the AC voltage between monitor/camera, monitor/extended monitor. Call the store or agency where you purchased this product and consult to solve the problem.
  - Beware that unfavorable damage might be caused due to authorizing AC voltage on communication wiring of monitor/camera, monitor/extended monitor.
  - Do not ever disjoint this product. It may cause electrocution accident when touching high-voltage circuit inside this product.
  - Outside power authorizing this product must be confirmed of product description and use rated voltage. Beware that if higher voltage is authorized, unfavorable damage might be caused due to product destruction.
  - Power must be connected to domestic voltage (product rated voltage) consent or interior wiring.
  - If connected to other motive power or inverter-type power, product destruction, noise mixing, and picture distortion may occur.
  - Do not drop this product. Glass is used for monitor and might break, or cause other circuit inferiority.
  - In such case, immediately turn down the power switch, and call to consult agency or store in which this product was purchased.
  - If installed near transmission antenna such as broadcasting station, electric wave may mix and cause picture distortion or voice mixing.
  - Avoid installing near tools with strong electromagnetic waves such as microwaves and cell phones, or it may cause picture distortion.
  - Do not install monitor in following places.
    - ① Above or around water heater, rice-cooker, heater
    - ② Place exposed to direct rays of the sun
    - ③ Place with temperature below 0°C such as cold store
    - ④ Place with high humidity such as bathroom, washroom, heated room
    - ⑤ Place with a lot of gas, dust, smoke
    - ⑥ Dangerous place with sprays of water or chemicals
  - Do not wipe with insecticide, drugs or chemicals such as thinner and alcohol, or it may damage the surface of this product.
  - Beware of occurrence of image quality deterioration or malfunction from cause of humidity due to penetration of chemicals or water into camera's urea resins.
  - As in the picture, it prevents temperature difference of camera (outside) and monitor (inside), and removes dew condensation caused by humidity of camera window.
  - Camera must be installed when wall cement is completely dry.
  - When product is installed in winter below -5°C, wait for approximately 2 hours to connect. Dew formation in monitor and camera due to temperature difference inside and outside may cause product defect.
  - Avoid installing monitor and camera in place directly exposed to heat or where gas noxiousness is highly occurring.

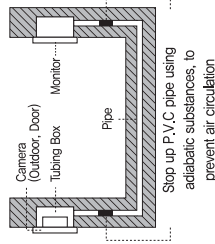

Stop up P.V.C pipe using adiabatic substances, to prevent air circulation









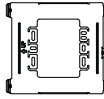

# CONTENTS

Videophone . . . . .	6
DVR . . . . .	22
DDNS . . . . .	39
CMS . . . . .	50
Mobile app . . . . .	68
Photo Converter . . . . .	72

## Before you call for A/S

- 1) Is the product power switch on?
  - Power is supplied to the product after turn on the Power SW at the bottom of product.
  - Please refer to the Manual for detail description.
- 2) Is SD Card mounted to the product?
  - It is not able to use video recording and album function without SD Card.
- 3) Is SD Card formatted?
  - If SD Card is not formatted, it may not work properly even though it is mounted.
  - You can confirm the SD Card format status from DVR MODE screen.
  - Menu Sequence : DVR MODE->SETUP->STORAGE->SD FORMAT
  - Please refer to the Manual for detail information.
- 4) Is SD Card compatible with the product?
  - The product may not work properly if SD Card is not compatible one.
  - Compatible SD Card list is in the Manual.
- 5) Removing SD Card during product operation.
  - SD CARD UNMOUNT popup window appears when pressing DVR MODE key at the right side of product for more than 1 seconds.
  - Press OK button, then remove SD Card.
  - To re-mount SD Card after unmount it, Mount SD Card and press DVR Mode key for more than 1 second.
  - Then SD CARD MOUNT popup window appears. Now press OK button and SD Card is ready to use.
  - SD CARD ERROR message appears when removing SD Card without pressing UNMOUNT button during operation.
  - SD Card is not recognized again even it is mounted when this message appears. In this case, you should turn off the power and reboot the product.
- 6) The product power should not be turned off, or should not remove SD Card by force.
  - There may be recorded data loss if power is or remove SD Card by force during recording. Please be careful for this.
- 7) Did you check product compatibility when use external hard disk to USB?
  - Product does not work properly when using incompatible hard disk drive.
  - Please refer to the Manual for detail information.
- 8) Is hard disk formatted when using external hard disk drive to USB?
  - Hard disk drive does not work properly if it is not formatted.
- Menu Sequence: DVR MODE->SETUP->STORAGE->AUTO-BACKUP
- Please refer to the Manual for detail information.
- 9) Did you setup Network?
  - You cannot access to network if the network setup is not completed.
  - Setup Menu Sequence: DVR MODE->SETUP->NETWORK
  - Please refer to the Manual for detail information.
- 10) Did you change the Network Client password and user password?
  - Please change Network Client password and user password. Factory setup default is 0000.
  - Network client password and user password is used to access to network. Please be sure to change it since it may cause security problem.
- Client password setup menu sequence: DVR MODE->SETUP->NETWORK->CLIENT
- Network user password setup menu sequence: DVR MODE->SETUP->NETWORK->USER
- Please refer to the Manual for detail information.
- 11) Did you change DVR Manager and user password setup?
  - You can change DVR Manager and user password.
  - Please be sure to change it since it may cause security problem.
- Setup Menu Sequence: DVR MODE->SETUP->SYSTEM->PASSWORD
- Please refer to the Manual for detail information.
- 12) Did you set the time?
  - DVR recorded time depends on the time of the product.
  - Be sure to check time and set correctly.
- It is able to receive time information from network time server when it is connected to network.
- Setup Menu Sequence: DVR MODE->SETUP->SYSTEM->TIME
- Please refer to the Manual for detail information.
- 13) Did you set the camera?
  - It is able to connect Door Camera and CCTV, and it should be changed at the setup item.
  - It may not work properly if the setup is not correctly made.
- Setup Menu Sequence: SETUP->VID- SETUP->CAMERA-SET
- Please refer to the Manual for detail information.
- 14) Did you convert the file when using album?
  - You need to convert the file when using album's picture file using file conversion program in the PC to use Album function.
  - Please refer to the Manual for detail information.
- 15) Did you make setup for the use of lamp/gas?
  - Corresponding items should be setup to use from Home Control in Setup Menu.
  - Setup Menu Sequence: SETUP->LAMP, CURTAIN
  - Please refer to the Manual for detail information.
- 16) Did you set the screen?
  - Default screen setup is to turn off the screen after 30 seconds of waiting time.
  - Normal screen mode comes back by touching the screen when it is turned off. It should be set at the Screen Setup to release screen turn off.
  - Setup Menu Sequence: SETUP->Screen set
  - Please refer to the Manual for detail information.
- 17) Do not use sharp end when touching the screen. It can be the cause of product failure.
- 18) Do not block air vent at the back of product when install it. It can be the cause of product failure.

## Components of videophone

- Monitor 
- A Wall hanger frame 
- Wire  Wire connecting to camera 4ea
-  Wire connecting to CCTV 4ea
-  Wire for connecting to monitor 1ea
- DC adapter / power code (applicable only for the DC type)  
- Screw  3X8 1ea
-  4X25 4ea
- SD CARD (\* Option) 
- Cradle (\* Option) 
- Install CD 

## SD CARD compatible SPEC

- 1) SANDISK : SDSDB-032G-B35 (32G / 4 CLASS)
  - 2) BARUN ELEC : EMBHAGMAF89SD (32G/10 CLASS)
  - 3) KINGMAX : P32GMJ0AM2LAC1 (32G/10 CLASS)
- ※ Do not use any SD card besides the one that is compatible. This may damage the product.  
The company will not be responsible for such damage.

## Components of door camera

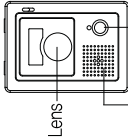
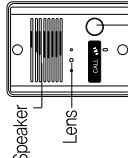
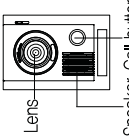
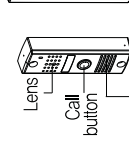
- [KC-C60]  Lens Speaker Call button Main body supporter
- [KC-MC24]  Speaker Lens Call button Main body supporter
- [KC-MC30]  Lens Speaker Call button Main body supporter
- [KC-MC20]  Lens Call button Speaker Main body supporter

## Installation location

### Monitor installation location

Standard monitor installation height is about 1,500mm where screen center is at eye level. In this case, wall-hanging metal center (center of piping) is 1,450mm above ground level.  
Standard installation height

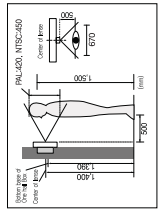

### Camera installation location

Camera installation in height Standard camera installation height is when lens is about 1,400mm above the floor. In this case, camera stack center (piping box) is above 1,350mm above ground level.  
Standard installation in height

※ The above angle of view is based on the KC-MC24 camera. The numbers vary according to the type of camera.

### Caution of camera installation

- Avoid installing camera exposed to direct ray of light (and sun).
- Beware backlight and darkness of visitor's face, which makes identification difficult.
- Avoid installing camera in places such as the following picture.
  - (1) Place illuminating sky as background
  - (2) Place with white wall reflecting direct ray of light
  - (3) Place with direct ray of light

### Monitor installation

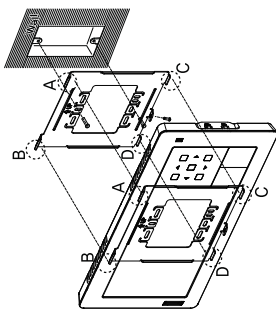

- Directly connecting cut-off power cord with power wire requires reliance on electric installation man with electric work license.
- 2) Insulate with insulating tape while cutting off power cord and connecting with power wire so electric wire metal does not expose. Contact between exposed electric wires causes fire or electric shock accident.
- 3) Such electric work requires connection after interception of supplied power.

- 1) Remove wall-hanger bracket metal behind monitor.
- 2) Install wall-hanger bracket metal on T type box or wall with attached Vis.
- 3) Connect wiring to monitor back terminal referring to product connection diagram.
- 4) Hang monitor on wall-hanging metal, and fix monitor on wall-hanger bracket metal using attached Vis.
- 5) Plug monitor's power plug into consent and check to see if the power switch is [ON] on the left side of monitor.

Cradle (optional) connection : connect by fitting in the groove at the monitor's backside and the Cradle's groove.

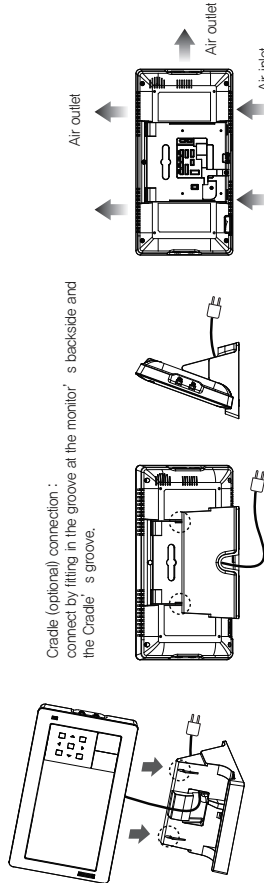

※ Precautions at the time of installation : install so that the air-ventilation hole at the back of the product does not get clogged. This could cause malfunction due to the heating of the product.

## Product connection diagram

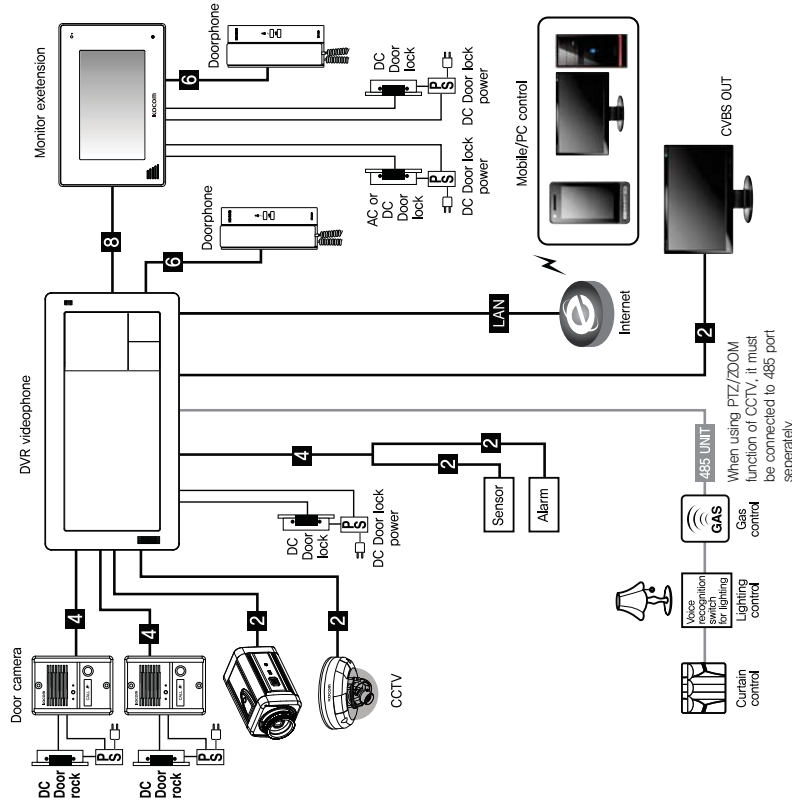

※ Enables connection of four cameras at the entrance or connection of four CCTV cameras.

※ Camera mode setup should be performed from monitor menu setup mode when connecting camera.

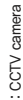

## Wiring diagram

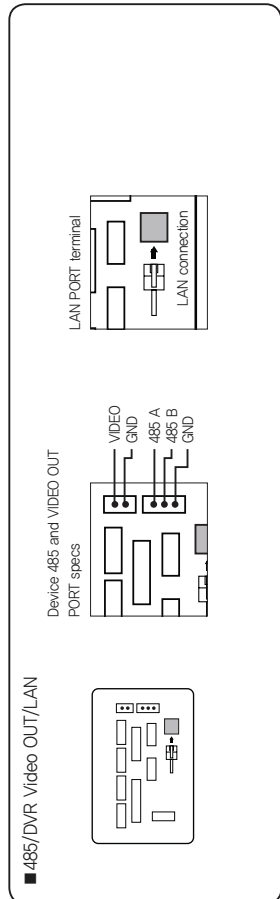
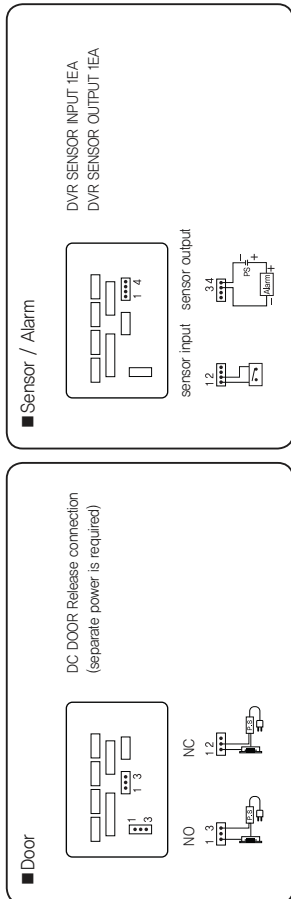
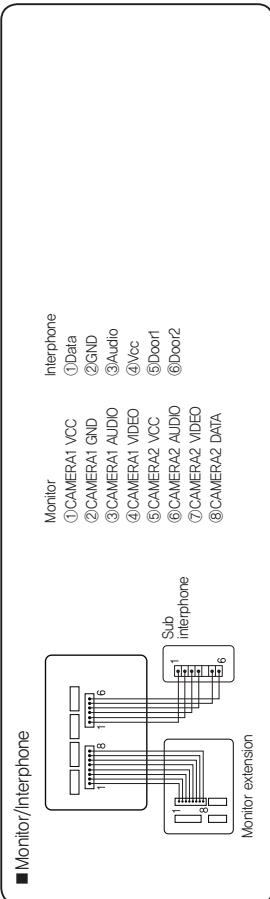
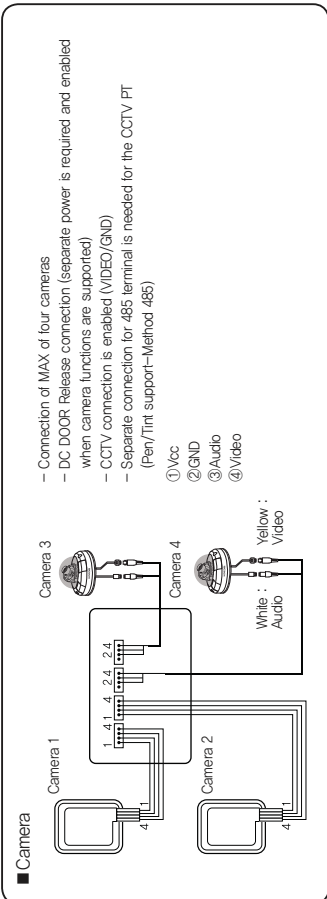

## Name and Functions of each part

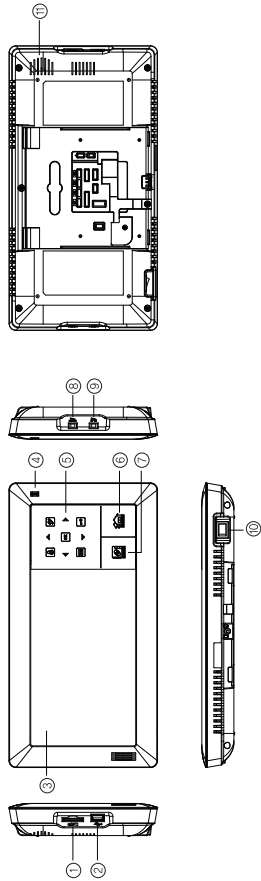

- ① SD card input section
  - ② USB input section
  - ③ Monitor screen (LCD)
  - ④ C-MIC
  - ⑤ Function key
  - ⑥ Moves to main screen
  - ⑦ Moves to DVR mode
  - ⑧ Call volume adjustment switch
  - ⑨ Speaking volume adjustment switch
  - ⑩ Power switch
  - ⑪ Speaker
- ⑬ Monitoring : move to video phone mode while at the main screen  
 Monitoring function at the video phone mode
- ⑭ Station call : monitor connected in an extended manner, page and call using the interphone  
 Emergency recording : forced recording of camera's image
- ⑮ Door opening : door opening function during call
- ⑯ Confirmation
- ⑰ Direction key : screen or cursor move while at the video phone, DVR, setting mode

## Main screen

It will enter to corresponding mode by pressing each mode icon from main screen.

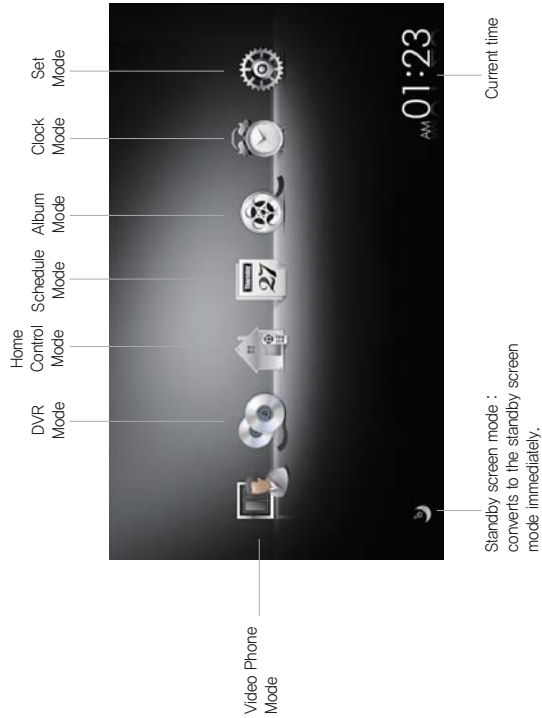

## Video phone mode

Moves to video phone mode screen when video phone icon or **[V]** key is pressed on while on the main screen.



※ It is able to change from Setting mode. Please check because it may work improperly when camera setup is different from its actual specification.  
 ※ Additional monitor can display only camera 1 and camera 2 image.  
 ※ It is not possible to record urgently without SD CARD.

## Station call and call

Monitor or interphone, connected in an extended manner is paged when the **[P]** icon is pressed on or when the **[V]** key is pressed on for a long time (at least 1 second).



Standby time for station call is 1 minute.  
 Call gets connected when the other party answers the call.  
 (Extension call time : 3 minutes)



Call gets connected when the **[V]** icon or **[V]** key is pressed on when paged from the extended monitor and interphone.



## Recording of the image on the current screen

Current screen is recorded when **[R]** icon or **[V]** key is pressed on.  
 Recording ends when record icon/key is pressed on once again.  
 Recording is enabled only during entrance monitoring and call from entrance.



When all the images of the camera at the entrance end while recording, it ends automatically.  
 Recorded image can be confirmed at the DVR mode.



## Paging and call from entrance

Orange color borderline is generated on the image of the camera at the entrance when page comes from the camera at the entrance.

When page comes from at least two cameras at the entrance, orange color borderline is generated on the image of the camera from where the last page arrived.  
 Standby time for paging is 2 minutes.



Door opens when the **[D]** icon or **[V]** key is pressed on during a call.  
 (Enabled while at the state in which switch is connected)  
 Operation time for door opening is up to 10 seconds. \*Modification is enabled at the video phone mode setting.

## Entrance monitoring

This is the function that is used to monitor the entrance only by confirming the image without calling.

Monitoring takes place while borderline gets generated when the screen of the camera at the entrance is touched once on the monitor.



Monitoring times are 1 (Default), 2, 3 and 4 minutes.  
 Setting is enabled at the setting mode.  
 Monitoring takes place at all times when CCTV that requires separate power is connected, and monitoring cannot be turned off forcibly.  
 (However, it is necessary to convert the camera setting to CCTV from the setting screen.)



## DVR mode

Moves to DVR mode screen when DVR mode icon is pressed on at the main screen.



Refer to the explanation on the DVR mode located at the back for details.

## Home control mode

Moves to home control mode screen when home control icon is pressed on while at the main screen.



- \* If a user presses a button [Go to the XX Control], a screen goes to the control screen. If a screen goes to the control screen of the device, a pop-up screen opens and checks the connection status of the device. It may take several tens of seconds in accordance with the status.
- If the device is not connected, a message "NOT CONNECT" is activated on the pop-up screen.
- If a user presses the pop-up screen once, it disappears.
- Only, a user may not select a device which is not connected.

## Lighting control

Moves to lighting control screen when lighting icon is pressed on while at the home control mode screen.

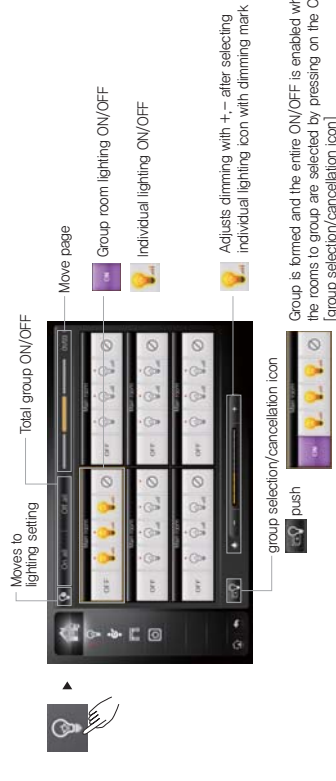

- 1) It is possible to add or delete a light on the screen of "LIGHT SET" of menu "SET".
- 2) Each Light On/Off
- 3) Room Light On/Off
- If a user presses a button [EACH] meaning each light, the light turns on, and if a user presses it again, the light turns off.
- 4) All Lights On/Off
- If a user presses a button [ON] in the room, all lights are turned on, and a button changes from [ON] to [OFF].
- 5) Group Light On/Off
- If a user presses a button [On all] or [Off all], all lights are turned on or off.
- Press a button [SELECT GROUP].
- Select rooms to form a group.
- If a user presses a button [On all] on the top, the lights in all rooms selected are turned on.
- If a user presses a button [Off all] on the top, the lights in all rooms selected are turned off.
- To release grouping, press a button [SELECT GROUP] once again.
- 6) Dimming Light Control
- Dimming control is applicable to each light only.
- Press a light to control.
- Control the steps of dimming using a dimming bar on the bottom.
- 7) Time Reservation
- It is possible to reserve a time for lighting on the screen of "LIGHT SET" of menu "SET".
- A light is automatically turned on or off according to the time reserved.



## Gas valve control

Moves to gas control screen gas valve icon is pressed on while at the home control mode screen.

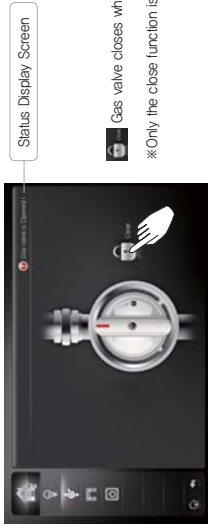

- 1) It is possible to close a gas valve only.
- 2) If a gas valve is opened, it displays on the status display screen.
- 3) A button [GAS CLOSE] is activated.
- 4) If a user presses a button [GAS CLOSE], a gas valve is closed.

※Only the close function is enabled for the gas valve.

## Curtain control

Moves to curtain control screen when curtain icon is pressed on while at the home control mode screen.



- 1) It is possible to add or delete a curtain on the screen of "CURTAIN SET" of menu "SET".
- 2) Curtain Open/Close/Stop
- If a user selects a curtain to open and then presses a button [OPEN], the curtain comes to open.
- If a user selects a curtain to close and then presses a button [CLOSE], the curtain comes to close.
- If a user presses a button [STOP] during a curtain is working, the curtain comes to stop.
- 3) All Curtains Open/Close
- If a user presses a button [Open All] or [Close All], all curtains come to open or close.
- 4) Time Reservation
- It is possible to reserve a time to open, close or stop a curtain on the screen of "CURTAIN SET" of menu "SET".
- A curtain is automatically opened or closed by the scenario.

If a scenario is added on the screen of "SET", a red dot is generated on the top of a curtain.

## Relay unit control

Moves to relay unit control screen when relay unit icon is pressed on while at the home control mode screen.



It is possible to turn on or off the device connected.

- 1) It is possible to turn on or off the point of contact of a Relay unit.
- 2) A Relay Unit has two (2) points of contact interlocked.
- 3) If a user presses the button of the point, it lights a light and turns on the point of contact.
- 4) If a user presses the point of contact which turns on again, it extinguishes a light and turns off the point.



## Scheduler mode

Move year and month to select desired date.



Indicated on the date when date is pressed on and one of the icons is selected. Press on the icon to write in the contents and save with the icon.



Saved schedule can be deleted using icon.



## Album mode

Converts to already set album mode when album icon is pressed on while at the main screen.



Image gets amplified proportionally, and it is not possible to increase or modify arbitrarily.



Touch the screen to end.

## Clock mode

Converts to clock mode image when clock icon is pressed on while at the main screen.



Schedule input is enabled when date is selected while at the clock mode.



## Setting mode

Moves to setting mode screen when setting icon is pressed on while at the main screen.



※ It is executed when save setting is conducted with the save icon after inputting into the setting while at each setting mode.

## Video phone setting

Moves to video phone setting screen when video phone setting icon is pressed on while at the setting mode screen.



Melody setting :  
selects extender or camera to change and modifies sound of the melody.

Camera setting :  
select camera to change and selects CCTV or camera at the entrance.

Monitor time setting :  
sets up monitoring time.

Time setting for door opening :  
sets up the time during which the door will be open after pressing on the door open button.

## DVR setting

Moves to DVR setting screen when icon is pressed on while pressing down on the DVR setting icon while at the setting mode screen.



Refer to the explanation on the DVR mode located at the back for details.

## Screen setting

Moves to screen setting when screen setting icon is pressed on white at the setting mode.



- Standby screen setting : Sets up the mode to operate on standby screen.
- Setting into album mode
- Setting into clock mode
- Setting into scheduler mode
- Setting into DVR mode
- Setting into screen OFF mode



QUAD background screen setting : Sets up camera QVAD screen background in the video phone/DVR mode.

Converts to standby screen mode when screen setting is completed.  
 icon is pressed on the main screen to convert immediately to standby mode without automatic operation time. Returns to previous operation time when the screen is touched or function key is pressed on white at the standby screen mode.  
 Default setting is screen OFF for LCD lifetime.

Sets up the automatic operation time that enters into standby screen mode.



## Lighting setting

Moves to lighting setting screen when lighting setting icon is pressed on white at the setting mode screen.



If repetitive reservation setting (every day, every week) is not checked, executed once at the set time.



Reservation time setting  
 Total lighting ON at the reserved time  
 Total lighting OFF at the reserved time  
 Test :  
 lighting is turned on at the reserved time and returns to the original state when pressed once again

- Save
- End
- Setting up group room's name
- Select group room and deletion or generation with -,+
- Generate icon
- Delete icon
- Select lighting and deletion or generation with -,+

1. Lighting Room Add or Delete
- 1) There is no any room at the beginning.
- 2) If a user presses an icon of a room and then presses a button [ADD], a room is added.
- 3) A room name starts from 'Name 1'.
- 4) The maximum number of rooms to be generated is 18 rooms.
- 5) Room ID is automatically given by increasing from '0' one by one in turns.
- 6) To delete a room, select a room to delete and then press a button [DELETE].
- 7) A room starts being deleted from the last one.



## Album setting

Moves to album setting screen when album setting icon is pressed on white at the setting mode screen.

- Move Amplify and view image
- Album time setting
- Select all the images
- Select all the images + Delete individual image
- + Delete all the images
- Import USB photo file
- Save End

Setup/Album Setup :  
 Only call, delete album file from USB is available.  
 Screen Setup/Album image Setup/Call Album image/Album Setup :  
 It selects or releases the file to execute from Album Mode.



Converts and moves the saved file to a USB to save in DVR video phone. Place in the USB into the DVR video phone, and imports photo album with the icon while at the album setting screen. Touch the photos to save in order to select them, and save with the icon. Saved images are listed when USB is taken out.

- Import image (format supported : JPG)
- Open the screen for converting various images
- Select folder to save
- Save

Conversion of various images



- Importing various images all at once
- Select folder to save
- Image conversion
- Cancellation

Photo file can import only the file converted on a PC by leveraging a program called the [PhotoConverter].  
 Execute the PhotoConverter-setupfile included in the CD to install the program on the PC.



Convert photo file by importing desired photo file by executing installed program. Select the folder to save and save with the save icon.

2. Light Add or Delete
- 1) Select a room to add a light.
- 2) If a user presses a button [ADD] after pressing a light (a general light / a dimmer light), a light is added.
- 3) The maximum number of lights to add in a room is 4 lights.
- 4) To delete a light, select a light to delete and then press a button [DELETE].
3. Room Name Modify
- 1) If a user presses a button [KEYBOARD] after selecting a room, a keyboard to input a room name is popped up.
- 2) If a user presses a button [OK] after inputting a room name, it is modified.
- 3) English is applicable to input a room name only.
4. Time Reservation
- 1) It is possible to reserve a time to each light.
- 2) It is possible to select [EACH] or [ALL] for a room and a light.
- 3) A user should select 'Daily' or 'Weekly' on the screen of 'Weekly Select' after selecting a room or a light.
- 4) If a user selects 'Daily', it runs everyday, and if he/she selects 'Weekly', a user can select a day of the week to run a reservation.
- 5) A user should select a menu 'Time Select' after completing the setting of 'Weekly Select'.
- 6) If a user wants to turn on or off a light, he/she can select a button [EACH] or [ALL].
- 7) A box 'ON' means a time to turn on a light and a box 'OFF' does a time to turn off it.
- 8) If a user presses a time after checking a box 'ON' or 'OFF', the color of time turns blue.
- 9) If the color of time turns blue, press a time button on the top according to the time when a user wants.
- 10) The figure of time is automatically controlled by pressing a time button.
- 11) A user should press a button [SAVE] after setting a time completely to save the time set.
- 12) If a time is completely reserved, a red dot is generated right on the light.
5. Button [TEST]
- 1) If a user presses a button [TEST], he/she can make a test about the motion of a light on the screen of 'SET'.
- 2) If a user presses a button [TEST], a pop-up screen is activated and it goes to a test mode.
- 3) If a user presses a button [EACH] for a light, an icon of the light turns light and the light turns on.
- 4) If a user presses a button [EACH] again, the light turns off.
- 5) On [TEST] mode, a button [ALL] is changed to [ALL ON].
- 6) If a user presses a button [ALL ON], all lights turn on.
- 7) If all lights turn on, a button [ALL ON] is changed to [ALL OFF].
- 8) If a user presses a button [ALL OFF], all lights turn off.
- 9) Only, a scenario motion runs on a control screen only.
- 10) If a user presses a button [TEST] again, he/she can exit from a [TEST] mode.

## Curtain setting

Moves to curtain setting screen when curtain setting icon is pressed on while at the setting mode screen.



Operates automatically at the reserved time when curtain is selected and when set to open/close.



- ▶▶▶ Set up the name of the group room
- ▶▶▶ Curtain open
- ▶▶▶ Curtain shut
- ▶▶▶ Curtain deletion
- ▶▶▶ Curtain generation



Reservation time setting (every day, every week)

- ▶▶▶ 12:34 Reservation time setting
- ▶▶▶ + Total OPEN at the reserved time
- ▶▶▶ + Total CLOSE at the reserved time
- ▶▶▶ Test

Curtain, set in the reservation setting gets executed. Returns to the original state when pressed on once again

- ▶▶▶ Save
- ▶▶▶ End

1. Curtain Add or Delete
  - 1) There is no any curtain at the beginning.
  - 2) If a user presses a button [ADD], a curtain is added.
  - 3) A curtain name starts from 'Name 1'
  - 4) The maximum number of curtains to be generated is 8 curtains.
  - 5) Curtain ID is automatically given by increasing from '0' one by one in turns.
  - 6) To delete a curtain, select a curtain to delete and then press a button [DELETE].
  - 7) A curtain starts being deleted from the last one.

2. Curtain Name Modify
  - 1) If a user presses a button [KEYBOARD] after selecting a curtain, a keyboard to input a curtain name is popped up.
  - 2) If a user presses a button [OK] after inputting a curtain name, it is modified.
  - 3) English is applicable to input a curtain name only.

3. Time Reserve
  - 1) It is possible to reserve a time to each curtain.
  - 2) It is possible to select a button [EACH] or [ALL] for a curtain.
  - 3) A user should select 'Daily' or 'Weekly' on the screen of 'Weekly Select' after selecting a curtain.
  - 4) If a user selects 'Daily', it runs everyday, and if he/she selects 'Weekly', a user can select a day of the week to run a reservation.
  - 5) A user should select a menu 'Time Select' after completing the setting of 'Weekly Select'.
  - 6) It is possible to select a time to open or close each or all curtains.
  - 7) A box 'OPEN' means a time to open a curtain and a box 'CLOSE' does a time to close it.
  - 8) If a user presses a time on the right side after checking a box 'OPEN' or 'CLOSE', the color of time turns blue.
  - 9) If the color of time turns blue, press a time button on the top according to the time when a user wants.
  - 10) The figure of time is automatically controlled by pressing a time button.
  - 11) A user should press a button [SAVE] after setting a time completely to save the time set.
  - 12) If a time is completely reserved, a red dot is generated right on the light.

4. TEST Button
  - 1) If a user presses a button [TEST], he/she can make a test about the motion of a curtain on the screen of 'SET'.
  - 2) If a user presses a button [TEST], a pop-up screen is activated and it goes to a [TEST] mode.
  - 3) If a user presses a button [OPEN] or [CLOSE] after pressing a button [EACH] for a curtain, the curtain becomes run.
  - 4) If a user presses a button [OPEN] or [CLOSE] after pressing a button [ALL], all curtains become open or close.
  - 5) Only, a scenario motion runs on a control screen only.
  - 6) If a user presses a button [TEST] again, he/she can exit from a [TEST] mode.

## Language setting

Moves to DVR language page when language setting icon is pressed on while at the setting mode screen.



LANGUAGE INCHUKIM  
Sets up to desired language.

## Warranty

▶ To receive after service, have the following ready before you contact our branches.

1. Name of the product.
2. Model number of the product.
3. The area of problem.
4. Phone number and address at which you can be contacted.

## Warranty Card

PRODUCT	
MODEL	
DATE PURCHASED	
WARRANTY PERIOD	
AGENCY ADDRESS	

▶ KOCOM Warranties the original purchaser of this product as follows.

- 1) This product is produced under strict quality control and inspection procedures.
- 2) If this product breaks down during proper use as a result of product defect, KOCOM will repair it within one year from date of purchase free of charge.
- 3) The following cases will be subject to charge, even during warranty period:
  - a. Breakdown during transport, or through careless treatment, by consumer.
  - b. Breakdown cause by unauthorized repair, or system modification.
  - c. Breakdown caused by natural disaster or power disorder.

Head Office : 7F, KOCOM., 663 Gonghang Main Streets, Gangseo-Gu,  
Seoul, 157-040, Korea  
http://www.kocom.com  
E-mail : export@kocom.co.kr

## 1. Screen Layout

You can see the below items according to your selection on function.

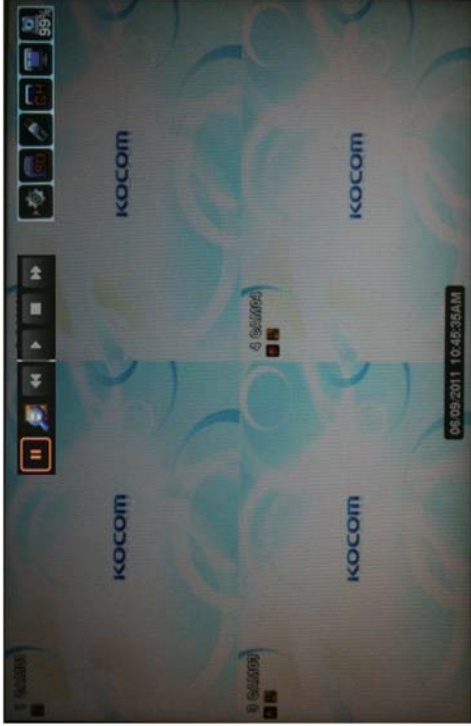

### 1.1. Icons in Live Display Mode

In Live display mode, icons will be indicated on the screen to notify the system mode or status. Below are the icon categories, which are indicated on the monitor.

Icon to be shown at right-upper corner on full screen mode	Icon to be shown at left-bottom corner on each channel
Selects specific CH for full screen	When Motion Detected
Screen-Division mode	When Sensor Activated
SD card capacity usage status	PTZ
When USB memory stick & HDD	Recording
SD card mounting/removal	
Entering menu	
When DVR is accessed via network	

Icon to be shown in 1ch full screen mode	
	Channel sequence mode
	Digital x2 Zoom

### 1.2. Playback Buttons

If you select search mode, the status will be shown in the upper side of screen.



	Now status	- This rectangular show the now status of playback. - If you select ▶, the mark will be changed to ▶, - And the mark will show ▶▶, when ▶▶ is selected
	Backward	- Control backward speed. - Move frame by frame reversely in pause mode
	Play	- Play the recorded data
	Pause	- Pause the playing data
	Fast Forward	- Control forward speed. - Move frame by frame forwardly in pause mode
	Stop	Stop the playback and go to Live mode
	Quick Search	- If you select this icon, the Search sub-menu will pop up

How to use Playback bar

MENU > SEARCH > select Search mode you want.

- Playback mode changing

To display different screen mode, select the Monitor icon on screen and select different mode.

You can control playback speed with ◀◀ / ▶▶ button. Select ◀◀ / ▶▶ button once then it will be x8, twice will be x32 then 3 times select is x128.

Select ■ button to stop playback and go back to live mode.

### 1.3. Other Icons

#### 1.3.1. CHANNEL ICON

You can change channel displays on screen. There are 1~4 in full screen.

#### 1.3.2. SCREEN SHOW STATUS

You can select how screen will display.

In Live MODE, there are 4 modes : Single, PIP, Sequence, Quad

In play mode, there are 2 modes : Single, Quad

#### 1.3.3. SD CARD STATUS

It shows the usage of SD card in percentage.

#### 1.3.4. USB ICON

This icon will be shown after you attach USB into DVR,

#### 1.3.5. SD CARD MOUNTING/REMOVAL ICON

Select this icon when you input SD card for mounting. (If mounting is not done, recording is not Starting). Select this icon when you remove SD card. (If removal is not done, it could cause damage SD card)

#### 1.3.6. ENTERING MENU ICON

To enter menu, select this icon or press DVR mode key on the machine.

#### 1.3.7. NETWORK ICON

This icon will be shown while someone access DVR through Network with CMS, or Web-viewer.

#### 1.4. PIP mode (picture in picture)

In case of full screen display mode, you can see other camera with a small window.

(1) Select screen mode icon and select PIP mode.



(2) If you select PIP button again in PIP mode, the position of two screens will change each other.

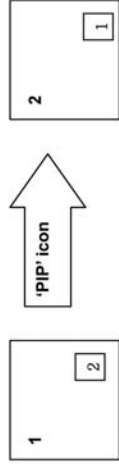

(3) Select Ch no. in PIP mode to change small screen to desired screen.

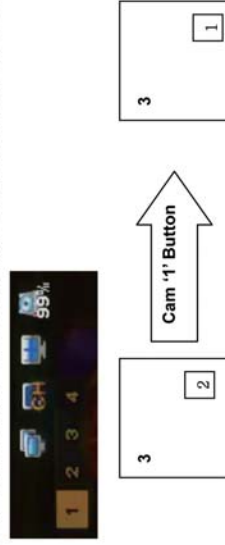

(4) Touch the screen or press direction keys to move small screen to desired position.

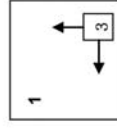

#### 1.5. Sequence mode

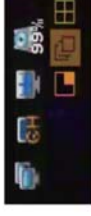

- If you select SEQ button in case of FULL or QUAD screen mode, screen(s) will rotate automatically.

- Default value of channel changing interval is 2 or 3 seconds.

- User can select interval time from 1 to 99 seconds at SETUP > DISPLAY > LIVE-SEQ(FULL)

- User can select desired channel to display

#### 1.6. Digital-ZOOM

Only in live mode, digital zoom function will work.

■ In full screen(1ch), select the icon in the top middle. Then, it gets into digital zoom mode.

■ If you select ZOOM key again, Zoom-Area window will be generated and you can move it to different position by touch screen or direction keys on the machine.

■ Move the area to position we want. Touch the area to enlarge it.

■ To get out of digital zoom mode, please press the DVR mode key on the machine.



## 2. HOW TO DISPLAY MENU WINDOW

Use touch screen or direction keys on the right side of KVR to select DVR menu or set up.



When using touch screen, press desired menu. For direction keys, you can move with it and select certain menu with OK key.

DVR mode key : This is quick button to get into DVR mode. In DVR mode, press this button to get into DVR setup mode.

## DVR MENU

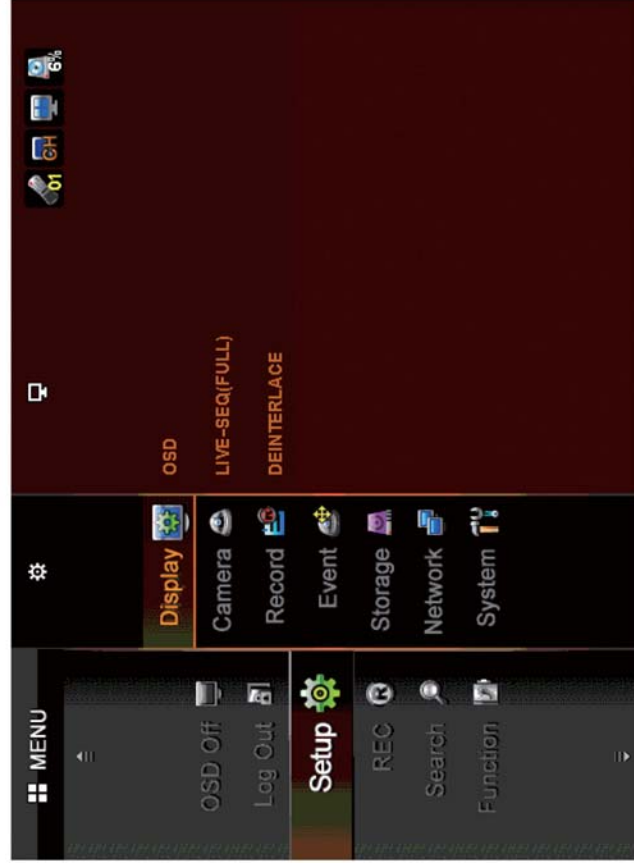

### SETUP

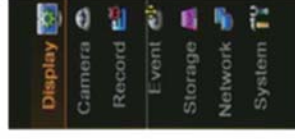

### FUNCTION

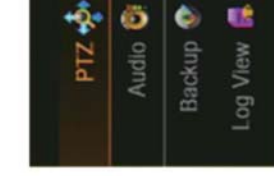

### SEARCH



## 2.1. SETUP

DISPLAY	CAMERA	RECORD	EVENT	STORAGE	SYSTEM
OSD LIVE-SEQ(FULL) SPOT-SEQ(FULL) DEINTERLACE	GENERAL PRIVATE ZONE PTZ PRESET SCAN POINT COLOR POSITION	PARAMETER SCHEDULE WATERMARK MISC	MOTION SENSOR E-MAIL E-MAIL SCHEDULE ALARM SCHEDULE MISC	SD FORMAT AUTO-BACKUP NETWORK SET UP STREAM DDNS CLIENT ACCESS LIST USER	CONFIG TIME PASSWORD KEY-TONE UPGRADE

### 3. SETUP MENU

Select "MENU ENTERING" icon or press DVR mode key to get into menu.

#### 3.1 DISPLAY



When you select Display icon, display menu is divided into 4 sub-menus;

OSD, LIVE-SEQ(FULL), SPOT-SEQ(FULL) and DEINTERLACE

#### 3.1.1. OSD

You can select which is displayed in the screen with choosing each icon.



- CAMERA NAME - Show camera name on screen.
- CAMERA NUMBER - Show each number of cameras on the screen.
- CAMERA BOARDER - Show outline of channel.
- LANGUAGE - Select OSD language.
- OSD HIDE - Hide all OSD, time, or icon bar
- AUTO HIDE - Hide status bar automatically during not using DVR.
- LEFT MARGIN - Move the OSD position of leftmost(E.g. Camera no, Name, Network, USB, etc)
- RIGHT MARGIN - Move the OSD position of rightmost (E.g. SD card, CH Status)
- TOP MARGIN - Move the OSD position to top (E.g. SD card, CH status)
- BOTTOM MARGIN - Move the OSD position of bottom (E.g. Time-bar)

Margin value accept the numbers from 00 to 99.

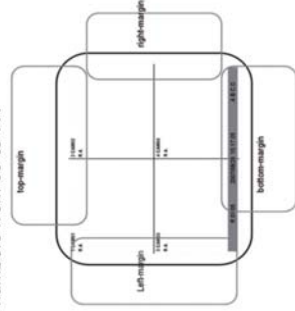

#### 3.1.2. DISPLAY-LIVE-SEQ(FULL)



- Set switching time to display a full screen in sequence.
- CH : Input desire channel no.
- TIME : Input desired switching time
- DEFAULT CH : Change to factory default value
- ALL TIME : same time is input to all channel.

**NOTE : The time is second and maximum 99 second for switching time can be entered.**

#### 3.1.3. SPOT-SEQ(FULL)



- Set switching time to display a full screen sequence on spot out monitor. (TV out)
- CH : Input desire channel no.
- TIME : Input desired switching time
- DEFAULT CH : Change to factory default value
- ALL TIME : same time is input to all channel.

#### 3.1.4. DEINTERLACE



Please select "ON" if you don't want to get interlaced video with D1 resolution, then video quality at D1 in playback will be better than setting "OFF".

### 3. 2. CAMERA



When you select Camera Icon, Camera menu is divided into 7 sub-menus;  
GENERAL, PRIVATE ZONE, PTZ, PRESET, SCAN POINT, COLOR, and POSITION

### 3.2.1. GENERAL



- NAME - Enter each camera name.  
Maximum 15 digits in English can be input.
- COVERT - Show or Hidden the camera in Live mode.  
ON: To covert, OFF: To show the camera
- AUDIO - Select connected audio channel.

### 3.2.2. PRIVATE ZONE

TO protect privacy, you can choose the zone which cannot be recorded as well as seen on screen.

- (1) Select letters that you wish.
- (2) You can type texts by touch screen.
- (3) You can type texts by direction keys on the machine.
- (4) Select OK button



### 3.2.3. PTZ

TO protect privacy, you can choose the zone which cannot be recorded as well as seen on screen.

- How to set up the private zone  
Select 1 square as starting point by touch screen or Direction keys on the machine.  
Select another square as ending point by touch screen Or direction keys on the machine.  
Then, private zone will be generated as seen left.

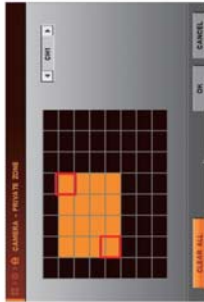

### 3.2.4. PRESET



- ID - Enter ID of PTZ camera.
- PROTOCOL - Select a protocol type of camera.
- BAUD - Select a baud rate of camera.

### 3.2.5. SCAN POINT



- CAMERA - Select specific camera to set up preset position.
- PAGE - Go to next page.
- CLEAR ALL - Cancel all saved presets.

(1) Select camera.

(2) Select **SET** icon.

(3) PTZ control screen of the camera will appear.

(4) Move pan, tilt, zoom in/out to desired point.

(5) Select Advance icon

Select any other position on screen or press **MENU** Key to cancel.

(6) if you like to cancel the setting, please select the **CLE** icon of the channel will be cleared. If you select "clear all" icon, all value of channels will be cleared.

### NOTE

- System records a certain position of PTZ device.
- Before using this function, please make sure that camera supports preset.
- Total 64 preset points can be saved to each channel.

### 3.2.6. COLOR

- CAMERA - Select a specific camera to set up SCAN points.
- LIST - Create another SCAN list
- PRESET - Select desired preset position.
- CLEAR ALL - Cancel all saved scan points.

### NOTE

- In SCAN point menu, you can set up PTZ tour route(SCAN-LIST) using saved PRESET position.
- You can create 4 scan lists for each camera. You should setup PTZ protocol and PRESET Positions before setting Scan-List.



EX) If you set as left,

Camera 1 will move to saved position as follows,

PRESET1 (3sec) → PRESET3 (3sec) → PRESET4 (3sec)  
→ PRESET5 (3sec) → Repeat .....

### 3.2.6. COLOR



- CAMERA - Select camera to set up color.
- BRIGHT - Adjust bright of camera.
- CONTRAST - Adjust contrast of camera.
- COLOR/SATURATION - Adjust saturation of camera.
- COLOR/HUE - Adjust hue of camera.
- DEFAULT - Set all values to factory default.



### 3.2.7. POSITION

Camera image can be larger than frame of DVR. In that case, use this function to adjust image.



- CAMERA - Select camera to adjust position.
- LEFT/RIGHT - Move camera position to LEFT or RIGHT in screen.
- DEFAULT - Set all values to factory default.

### 3.3. RECORD



When you select Record Icon, Record menu is divided into 4 sub-menus;

Parameter, Schedule, Watermark, and MISC

#### 3.3.1. PARAMETER

- RESOLUTION - Use this menu to specify the size of a screen to be recorded.



	NTSC	PAL
720 x 480	720 x 480	720 x 576
720 x 240	720 x 240	720 x 288
360 x 240	360 x 240	360 x 288

- EVENT
    - You can select the recording picture quality and frame rate for EVENT situation.
    - Activated when "REC MODE" is EVENT or motion/sensor recording according to schedule.
    - Each channel can be selected each different picture quality and frame rate
  - NORMAL
    - You can select the recording picture quality and frame rate for NORMAL situation.
    - Activated when "REC MODE" is CONTINUOUS or continuous recording according to schedule.
    - Each channel can be selected each different picture quality and frame rate
    - The frame rate in Normal mode can not exceed that in Event mode.
- If the frame rate of Event is set up as 8, and that of Norma mode can not exceed 8.

NOTE : You can set "REC MODE" at SETUP > RECORDING > MISC.

Record Quality	Picture Quality	Disk Space Need
BASIC	Low	Least
NORMAL	Fair	Medium
HIGH	Good	Big
BEST	Excellent	Most

- ALL
- All channels would be changed according to selected resolution or quality or frame rate.
- REMAIN XXX / XXX / XXX
- Indicate the remaining frame number to record based on each resolution.

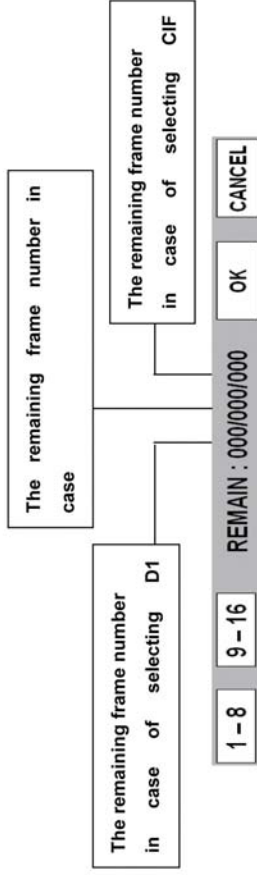

#### 3.3.2. SCHEDULE

- System records according to schedule setting when REC MODE is set SCHEDULE.
  - Specify the weekly schedule for each camera (hourly based)
    - ▶ WATCH : No recording
    - ▶ CONTINUOUS : Recording video continuously 24 hours a day.
    - ▶ EVENTS : Recording video when event(Motion/Sensor/Video Loss) is triggered.
    - ▶ CONT + EVENTS : Recording video when continuous or event is operated.
- If there is no event, it will record video as continuous mode and if there is event, it will record video as event mode as you set.
- NOTE : The time in the first column of each line means 00 :00 -00:59.



### 3.3.3. WATER-MARK

If you select ON in water-mark window, the recording data will include water-mark.  
Data Verification can be checked in the backup-viewer whether falsified or not.



### 3.3.4. MISC

#### • OVERWRITE

If you select ON in overwrite, the oldest recorded files will be overwritten by newly recorded data when SD card becomes full.  
If you select OFF in overwrite, the DVR will not record anything more when SD card becomes full.  
OVERWRITE ON/OFF will be applied to external HDD if external is connected.

We recommend that you select ON.

#### • AUTO-DELETE

The data before assigned date will be deleted according to the date you input.  
The value of 0(zero) disables AUTO-DELETE function.

#### • REC MODE

- Schedule - System records according to recording schedule
- Continue - Continuous recording all the time for all channels
- Event - Event (motion/sensor) recording all the time for all channels.



### 3.4. EVENT



**NOTE :** Event works when event in menu was selected at first, so you should set recording schedule to record a event and then set Record mode to **EVENT : SETUP** → **RECORD** → **MISC** → **REC MODE** → **EVENT**

#### 3.4.1. MOTION

- MOTION-AREA - Set the area to detect motion.
  - ▶ ALL - Select the whole area.
  - ▶ PART - Select a block.

- ▶ CLEAR ALL - Cancel the whole area.
- SENSITIVITY - Set the sensitivity of motion detection.  
Sensitivity degree : 0 < 1 < 2 < ..... < 9
- ALARM-OUT - Set the alarm-out when motion is detected.

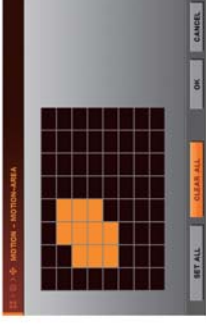

#### 3.4.2. SENSOR

- RECORD - Select channel to record when a signal is detected from Sensor.
- TYPE - Select sensor type to match sensor type you have.
- ALARM-OUT - Set the alarm-out when a signal is detected.



#### 3.4.3. E-MAIL

When below events happen, which will be notified to the registered email address by E-mail. You can register three email address. Please remind that you can select event type after selecting Event email is ON.

- MOTION
- POWER ON
- SENSOR
- SD card ERROR
- VLOSS



**Event E-mail :** Select ALL TIME or SCHEDULE to use Email notification.

**Event type :** Select Event type to notify by email

**SENDER ID :** Input DVR name or letters

**E-mail address :** Input your email address to receive event information from DVR.

For example : [anyone@gmail.com](mailto:anyone@gmail.com)

Select SENDER ID or E-MAIL ADDRESS then text input window will pop up. Type in SENDER ID and E-MAIL ADDRESS you wish.



Ex) Email message

From : DVR@dvr.com  
 To : anyone@gmail.com  
 Sent: Friday, July 24, 2009 6:11 PM  
 Subject: EVENT MESSAGE  
 [2009/07/24 18:10:11] [testdvr/192.168.001.121] MOTION ch 1 ON

### 3.4.4. E-MAIL SCHEDULE

This function works when you select SCHEDULE as the value of EVENT E-MAIL in E-mail MENU. You can get email from DVR according to schedule you select date or time.

### 3.4.5. ALARM SCHEDULE

If you select the date or time you want, the Buzzer goes off, after the value of alarm-out was chosen as any value in each sub menu of EVENT, when the related things happen during the selected times.



### 3.4.6. MISC

- PRE-REC TIME - Enter recording time (0-30sec) before the time when event occurs
- POST-REC TIME - Enter recording time (0-120sec) after the time event occurs.
- BUZZER - Buzzer will be sounded when alarm is out, if ON is selected.
- DWELL TIME - Enter the duration time of alarm out when event occurs.



## 3.5. STORAGE

### 3.5.1. SD FORMAT

If you want to format SD card, please select FORMAT button



### 3.5.2. AUTO-BACKUP (MIRROR)

You can connect USB type external HDD into DVR to use mirroring function.

You can use MIRROR function after connecting USB external HDD. Max 2TB external HDD can be connected. (2.5/3.5 inch type all supported regardless of internal or external power source)

- Mirroring : The same data being recorded in SD card will be recorded in external HDD. For instance, if SD card is 32GB & external HDD is 500GB, external HDD will keep recorded data until SD card overwrites 15 times. Because external HDD records same data as SD card does, it can protect data more strongly.
- If you want to format external HDD in this menu, HDD is formatted as file system FAT32 and backup viewer is copied in external HDD.



- FORMAT : Select FORMAT button. After completion of FORMAT, data will be recorded as FAT32 file system and backup viewer file will automatically be copied in the external HDD.
- SHOW : Select SHOW button and you can check file lists saved in external HDD.

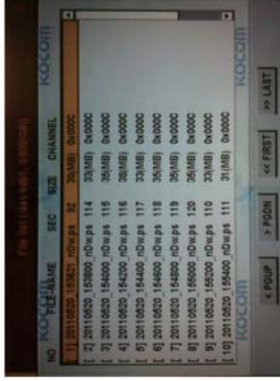

kinds of parameter can be chosen



Resolution	Normal	Frame
176*144	Basic	1, 2, 3,
360*288	Normal	6, 12, 25
	High	
	Best	

### 3.6.3. DDNS

DVR supports DDNSCCTV.COM for DDNS connection.

**NOTE :** Before setting DDNS, you should be registered on the website at <http://ddnscctv.com>

Please refer below for details.



- SERVER - Choose server type.
  - USER ID - Enter your site ID be registered on website
  - PASSWORD - Enter your site PASSWORD be registered on website
  - HOST NAME - Enter your host name be registered on website.
- After setup of DDNS, select TEST icon to verify the connection to DDNS site.

### 3.6. NETWORK



#### 3.6.1. SETUP

(1) STATIC,

Basically, you can choose one among STATIC, DHCP, and ADSL(PPPOE). If you choose DHCP mode, DVR system gets IP address automatically from IP router if connected, and if you choose STATIC mode, input IP address which is connected to DVR.

(2) ADSL(PPPOE)

If you use ADSL model, select ADSL and enter PPPOE ID and PASSWORD. If you don't know ID and Password, please contact your ADSL service provider.



#### 3.6.2. STREAM

You can set up the recording rate and Network transfer rate separately. If you select "ON" in dual streaming, you can set up the network transfer rate differently with the recording rate. Note that network transmission rate will be max. 120fps at CIF resolution if it is 'ON'. If you select "OFF" in dual streaming, the network transfer rate follows the recording rate.

- Registering at DDNS server (<http://ddnscctv.com>)

- 1) Input <http://ddnscctv.com> on web browser to connect DDNS server.
- 2) If you don't have account, click Registration button.

- 3) Fill in E-mail address, password, name and etc.. Then, click Submit button.

- 4) Input domain name you wish to create and click Request Domain button.  
Domain name can be created with combinations of alphabets, numbers and marks.  
(You must not put a mark on first letter of domain name.)
- 5) Click Logout button after domain name has been successfully registered.
- 6) You can log on with E-mail and password you registered.

- DDNS use

Input domain name you registered on web browser.

EX) <http://bluemoon.ddnscctv.com>

For WAN connection, DVR web port/client port should be forwarded. (Port-forwarding)

In this case, input : (colon) web port.

EX) If web port is set 1000 on DVR, <http://bluemoon.ddnscctv.com:1000>

### 3.6.4. CLIENT

Set password for netuser. Netuser is user that can access to DVR only via network (CMS or Web viewer)

Choose one of given CLIENT PORT list, and enter desired value at WEB PORT, whose default value is 0080. Remember those values you have entered for the following setup. For WAN connection, you have to set port forwarding in router with the selected web, client port on DVR. For more details, please refer to the manual of your router.

### 3.6.5. ACCESS LIST

Registered IP address is allowed to access DVR. If you set at least one IP address, then only entered Client IP address(es) would be allowed to access DVR. However, if you do not register any client IP address, any clients can access DVR.

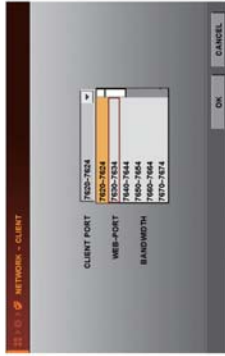

### 3.6.6. USER

Register up to 4 users that can access to DVR remotely via network (CMS, Web and mobile phone application) -Default ID : USER1, USER2, USER3, USER4 - Password : 0000



### 3.7. SYSTEM



#### 3.7.1. CONFIG

You can save(import) system setting values to USB device or can load(export) system setting values from USB device in order to make other DVR(s) as same setting values .

- CONFIG IMPORT- Load the saved configuration file from USB device and input to product.
- CONFIG EXPORT- Save present system configuration values to USB device.
- DEFAULT - Change setting value to factory default.



#### 3.7.2. TIME



- DATE FORMAT - Select Date format.
- TIME FORMAT - Select type of time indication
- TIME ZONE - Select your area to make adjustment of time zone.  
Please remind that the system will reboot, when you change the time zone.
- TIME SYNC
  - This function is for synchronizing the time of DVR periodically with that of the connected server by every hour.
- SERVER IP - Enter IP address of time server.  
Select TEST and press ENTER button to check if time sever is working.  
If this function is selected, DVR refer the time of Time zone every one hour, And then time of DVR will be changed to match that of time server.  
E.g. time.kriss.re.kr (www.time.kriss.re.kr → X)
- CHANGE TIME - Time will be changed by manual if the time server is not selected.

#### 3.7.3. PASSWORD

There are 2 users who can control DVR (ADMIN, USER). In this menu, you can modify password for the users. You can also check ON/OFF for SETUP, LOGIN, RECORD, SEARCH, BACKUP and checked functions would require password when you want to get into them.



### 3.7.4. KEY-TONE

Select ON/OFF for key-tone sound.

### 3.7.5. UPGRADE

If you open this menu, you can see the current firmware version of DVR.  
 If you would like to upgrade firmware of DVR, please follow the below steps.  
 If you select upgrade icon, the small upgrade window will pop up  
 There are two ways; USB UPGRADE, NETWORK UPGRADE.

- NOTE :** There is two methods to upgrade the DVR system.
- USB UPDATE - Upgrade the DVR system by using USB memory stick.
  - NETWORK UPDATE - Upgrade the DVR system through Internet.



#### 3.7.5.1 USB UPGRADE

Please select USB upgrade in upgrade window

- (1) Copy provided firmware file to your USB memory stick
- (2) Attach USB Memory which includes Firmware into USB Port.
- (3) Enter UPGRADE icon to upgrade firmware, then small windows will appear.
- (4) Please select OK icon and the message dialogue to confirm will popup,
- (5) And please select OK, or CANCEL to proceed.
- (6) It will take some minutes to upgrade, and then DVR will be rebooted automatically after upgrade is finished.

#### 3.7.5.2. Network upgrade

Please select network upgrade in upgrade window

- (1) Select UPGRADE , then small window will appear.
- (2) Select NETWORK UPGRADE and press ENTER button.
- (3) Check out whether Server IP and FILE NAME are correct. If shown information is wrong,

correct SERVER IP and FILE NAME and press ENTER button to input new information by text input Dialog box.

**NOTE :** Make sure the information of Server IP & File name through your supplier.

- (4) Select OK and press ENTER button to start S/W upgrade.  
 After completing upgrade, the system will reboot automatically.

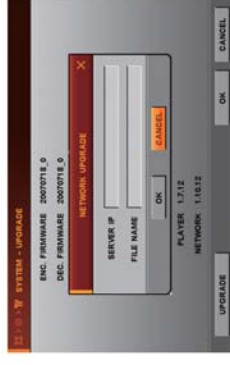

## 4. SEARCH

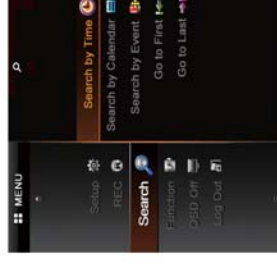

This Menu is divided into 5 sub-menu;  
 By time, By Calendar, By Event, Go to first and Go to last.  
 Please Select or press SEARCH button, The Sub-menu of SEARCH will pop-up. And then if you select the value in one of them, the playback bar Will be shown, and please see the page 13 to get how to control.

### 4.1. SEARCH BY TIME



- (1) Enter desired date and time to search for.
- (2) Then, move the pointer to OK and press ENTER button.  
 It is the start point to play back the data.

### 4.2. SEARCH BY CALENDAR

- (1) If you select SEARCH BY CALENDAR, the calendar will appear as the below.
- (2) Select desired date by pressing ◀▶▶▶ buttons and press ENTER button.
- (3) Select desired Hour/Min by pressing ◀▶▶▶ buttons and press ENTER button.
- (4) Select OK and press ENTER button.

### NOTE

- The color of Date is gray if there is no any recording. But the color of date turns Black when the recording data of that date exists.

- When you select the date which turned Black, the time bar will be shown including white, and red rectangular on Hour and Minutes.  
White bar does not include recording data, and the data exist in red color.  
If you select one red rectangular of Hour bar, its color changed to brown, and the color of minute bar will be changed to red if there is recording data in those minutes.  
And then, if you select one of these rectangular, the starting point is selected to play the recording data. The data will be played back when you select OK icon.
- Using arrow icons at the end of HOUR/MIN bar, you can adjust hour or time for search.



#### 4.3. SEARCH BY EVENT

- (1) If you select SEARCH BY EVENT, the following window will appear.
- (2) Enter desired start time and end time to find EVENT.
- (3) Select desired channel to search for.
- (4) Select desired event type to search for.
- (5) Select SEARCH button and press ENTER button.



- 4.4. GO TO FIRST : Play starts from oldest recorded data.
- 4.5. GO TO LAST : Play starts from latest recorded data.

#### 5. FUNCTION

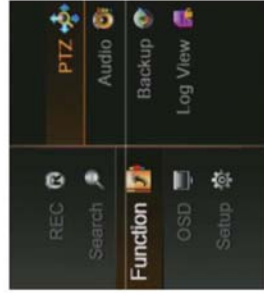

FUNCTION menu is divided into 4 sub-menu; PTZ, AUDIO, BACKUP, and LOG VIEW

#### 5.1. PTZ

- Select PTZ in Function Menu, screen will be changed to FULL screen mode and you can control PTZ camera.
- If you select advance icon in PTZ window, PTZ- ADVANCE window will pop-up.

##### 5.1.1. PTZ BASIC



- If you press ◀▶▶▶▶▶ button, camera will pan to left / right or tilt up / down.
- If you press ◀◀◀◀◀◀ / ▶▶▶▶▶▶ button or Select (+), (-) Icon, the camera will zoom in or out.

##### 5.1.2. PTZ ADVANCE

- FOCUS
  - ① + : Focus-IN.
  - ② - : Focus-OUT
  - ③ AUTO : AUTO-FOCUS mode.
- IRIS
  - ① + : Open Iris.
  - ② - : Close Iris.
  - ③ AUTO : AUTO-IRIS mode.
- SPEED
  - ① + : The control speed will increase.
  - ② - : The control speed will decrease.
- PRESET
  - ① If you want to go to a specific PRESET-position, select “GO” button.
  - ② If you want to scan PRESET-positions, select “SCAN” button



#### NOTE

- The PRESET-positions are set by PRESET menu [MENU → SETUP → CAMERA → PRESET]
- The SCAN-lists are set by SCAN-POINT menu [MENU → SETUP → CAMERA → SCAN-POINT]

- OSD MENU

If you select OSD MENU icon in case that Camera itself has OSD function, The OSD will be shown in accordance with Camera's OSD.

If OSD is not supported by Camera, OSD MENU does not work.

#### NOTE

- OSD Control function supports only for “Pelco-D” protocol



## 6. OSD OFF

If you select OSD OFF in MAIN MENU, something displayed on screen will disappear according to your selection on OSD MENU

You can get more information on this below.

[ SETUP->DISPLAY->OSD->OSD HIDE-> EACH PARAMETER ]

## 7. REC

If you select REC in main Menu, recording will start or be stopped by toggle. The some steps should be advanced before record is selected.

Please Check whether the value of date and time is properly set.

- Check if SD card is formatted. (if external HDD is connected, please format external HDD too)

[SD card /external FORMAT : SETUP >> STORAGE >> SD FORMAT or AUTO-BACKUP]

## 5.2. Audio

- Select ON/OFF for audio out or select volume.
- Audio works only at full screen mode.
- Audio doesn't work in videophone mode.



## 5.3. Backup

You can back up the data you want to store or keep to USB Device.

For USB backup, connect USB device to USB port of DVR system.

Select Channel and time you want, and then move and Select the pointer to BACKUP Icon.

- DEVICE - Select device to backup
- CHANNEL - Select desired channel
- TO AVI - Can make backup file as AVI file
- SMI - Time stamp to indicate time / data at AVI file.
  - Backup viewer is automatically copied to the device together with backup data
- FROM - Enter starting date time to backup
- TO - Enter ending date time to backup



## NOTE

- One channel only can be selected and can backup by USB memory

- Backup viewer is automatically copied to the device together with backup

## 5.4. Log view

- You can see the system log status or save it into USB memory and see it in PC.
  - EVENT TYPE - Select desired event type
  - FROM - Enter starting date & time
  - TO - Enter ending date & time
  - BACKUP - Save log data into USB memory
  - SEARCH - If you select SEARCH Icon, you can see log list in DVR.



## 8. Network access (CMS, Web viewer)

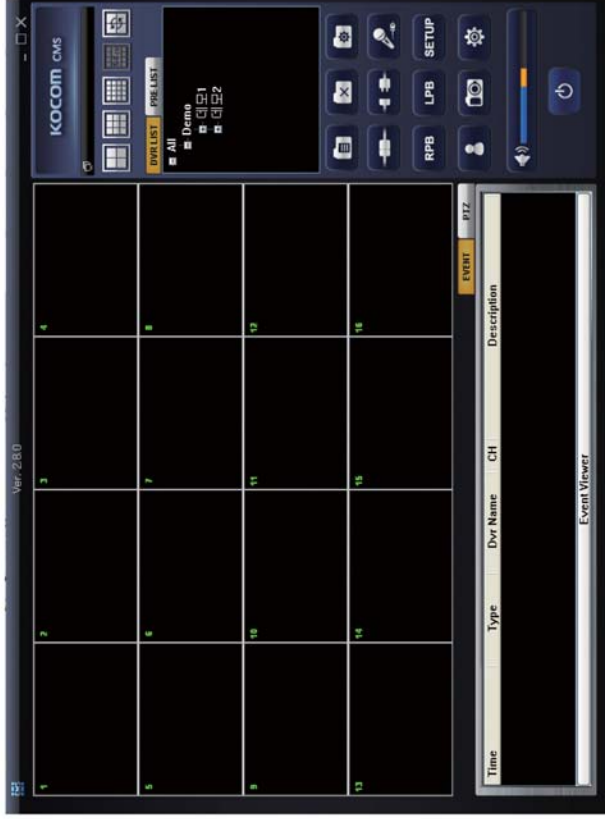

- System requirements for PC
  - Operating system : Windows XP / Vista / Windows7
  - CPU : Dual core or Higher
  - Ram : At least 1GB (2GB or higher memory recommended)
  - VGA : 128MB graphic memory or More

### 8.2. Program Installation



1-2-1 Find CMS installing program, and execute it.



1-2-2 After installation, the CMS icon will be created on the desktop.

### 8.3. Log In

When S/W is executed, Login window will be shown.  
Input your ID and password.

- \* Default ID : admin , Password : admin.

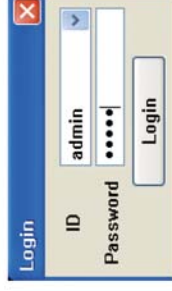

## 8.1. General information

- CMS program is an application with which users not only watch and control remote DVRs, but also receive video/audio data or alarm signals with LAN, WAN environment.
- CMS enables users who care about security to manage full information from all the wire-connected DVRs. All security administrators can control all situations even in emergency with easy operation in their PC.
- Main features of CMS program is as follows,
  - Real time monitoring multi DVRs at the same time
  - Up to 64 camera display on a screen
  - Various screen mode supported. (1, 4, 8, 9, 16, 25, 36, 49, 64 screen mode)
  - Remote controlling DVR setting value / PTZ camera
  - Change configuration values of DVR remotely

## 8.4. How to use CMS

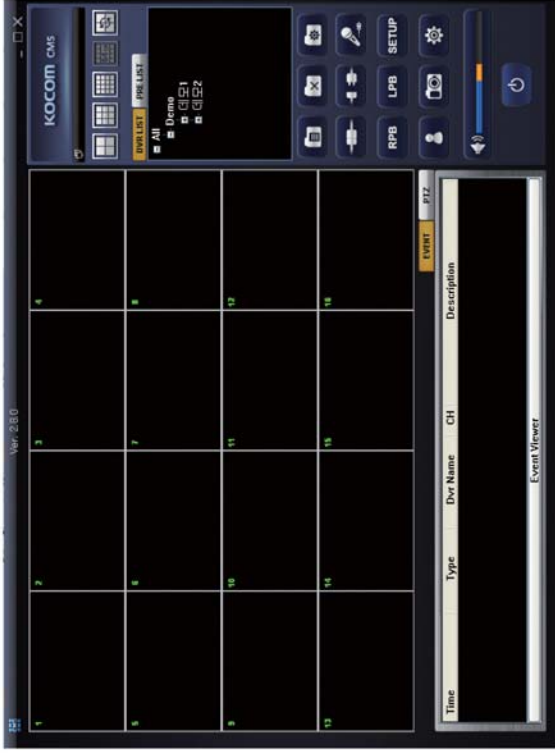

### 8.4.1.2. MAIN ICONS

- 1) ADD : Create Group or DVR site in DVR LIST window / Set prelist info window.
- 2) Delete : Delete created Group or DVR site in DVR LIST window / Delete PRE LIST window.
- 3) Modify : Modify the information of the registered Group or DVR site in DVRLIST window, or cameras in PRELIST window.
- 4) Connect : Connect registered DVR.
- 5) Disconnect : Disconnect the connected DVR.
- 6) Two-way Audio : Two-way audio communication thru CMS. (Between DVR site and PC)
- 7) RPB : Remote Playback Mode (Playback data on remote DVR)
- 8) LPB : Local Playback Mode (Playback backup data in PS format)
- 9) SETUP : Remote setup Mode (set up remote DVR)
- 10) User control : Create or delete new user of CMS.
- 11) Snapshot : Capture the Frame of one channel
- 12) Config : Set up CMS
- 13) Network transmission : Size of transmission data receiving from remote DVR. The faster bar moves, the more size data receives.
- 13) EVENT : shows CMS status and event logs
- 14) PTZ : PTZ camera control on 1ch division mode
- 15) Volume : Adjust audio volume
- 16) Power off : Close CMS program



### 8.4.2. DVR LIST

DVR LIST shows the information of the registered DVR in CMS.

To register DVR in CMS, please follow the below steps;

After you input PW in Login window, you can see operating CMS program.

You can make DVR list to connect and all camera of the DVR will be displayed in the connection.

- 1) Please select **ALL** and then click **ADD** folder **ICON**.
- 2) Please input Group name, then the group name will be created as tree of ALL.
- 3) Please select the group name and then click add folder **ICON** again, and then the Site window will pop up.

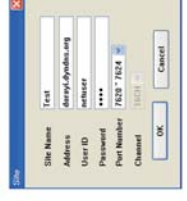

### 8.4.1. ICONS in initial screen

#### 8.4.1.1. Screen division option



S/W displays the channel mode automatically according to channel quantity of connected DVRs.

Also, you can select the channel mode among 4 / 9 / 16 / 64 channel mode.

You can see full screen mode by clicking maximize button



You can see one channel mode by double clicking.

### 8.4.3.1. Making display List

To make the list to display the channel from more than one DVR, please make the display list.

- 1) Please click "PRE LIST" on window.
- 2) Please select the group on the list

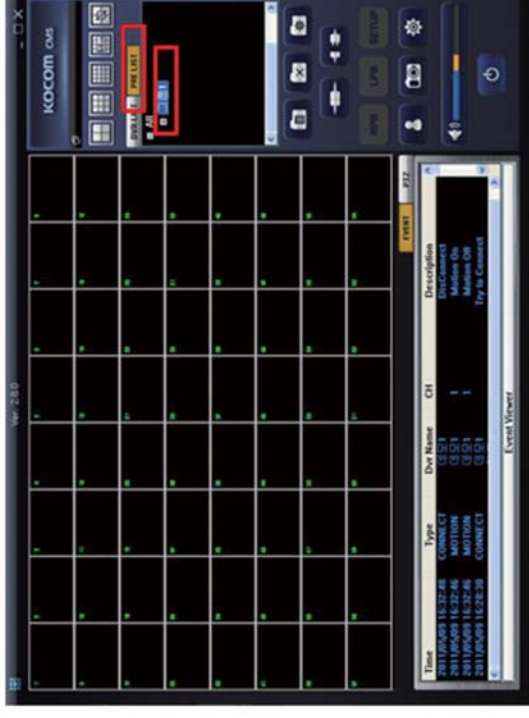

- 3) After selecting group, click ADD button

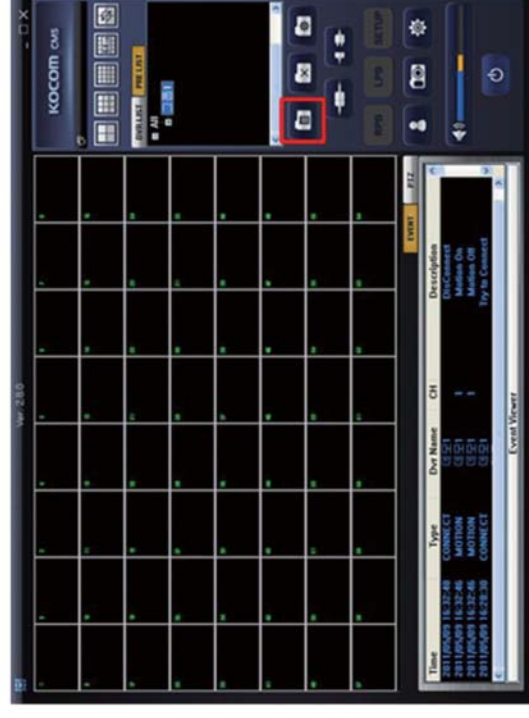

- 4) Please input each value in window.

Site Name : Please input DVR site name.

Address : Please input the same IP address as DVR you set up in DVR

User ID : Please input the same user name in DVR

Password : please input the same password as that of DVR

Port Number : please input client port number of DVR

The default value is netuser in User ID, and 0000 in password. The Network status in 4.2.7.4.

USER should be checked for users to see DVR with CMS.

- 5) Please click OK ICON, and then the status of DVR you selected will be shown in small window.

- 6) Please click connection ICON, the DVR will be connected.

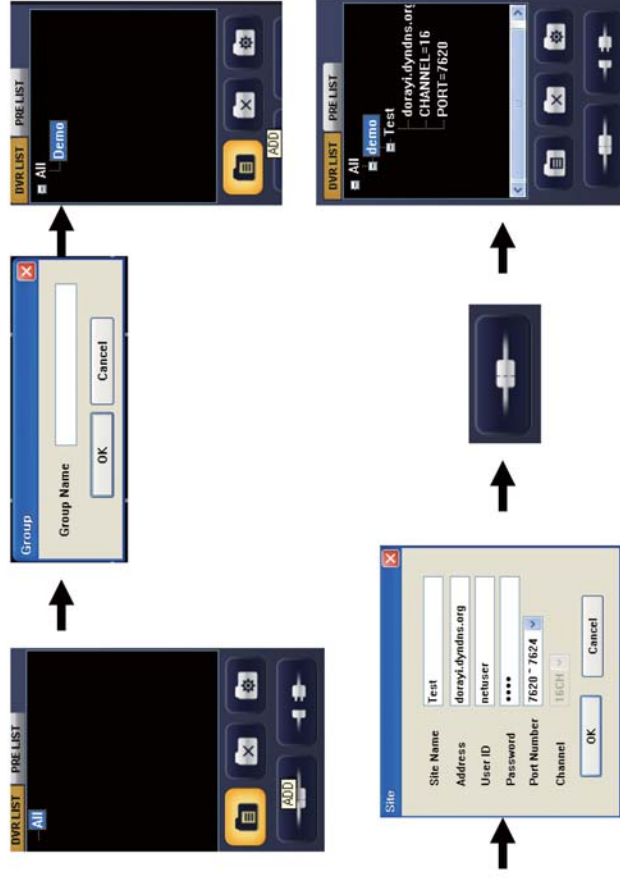

### 8.4.3. PRE LIST

It is the function to make the list to display the channel from more than one DVR.

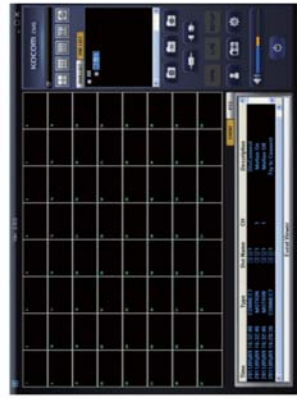

- 4) Please select registered DVR. Select DVR or cameras and drag to the right screen division.
- 5) Click OK to save the setup.

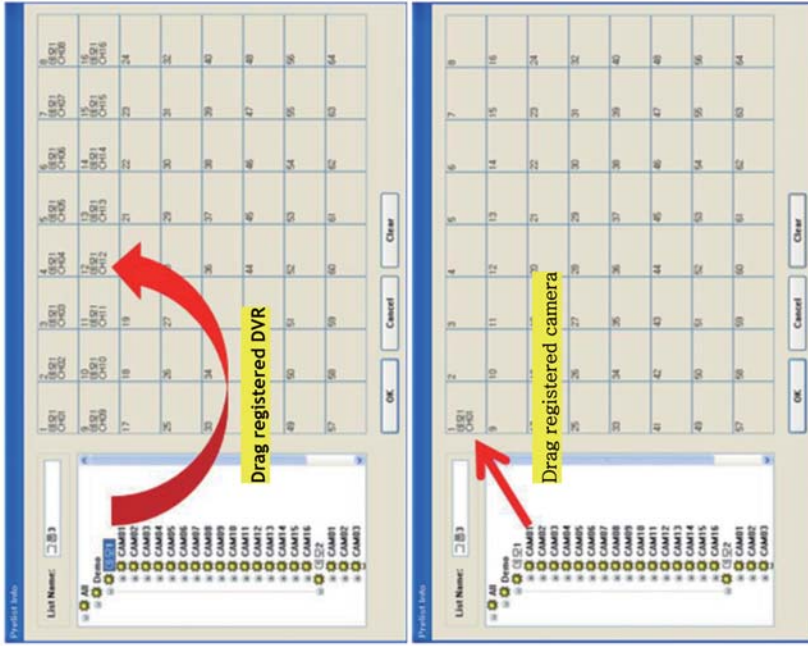

#### 8.4.4. PTZ control

PTZ camera can be controlled in 1ch screen mode on CMS.  
Click PTZ button as below. Event window disappears and PTZ control window shows up.

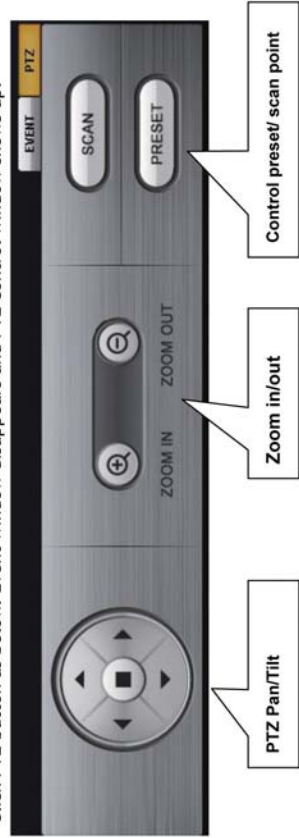

At DVR LIST : You can control PTZ after selecting the DVR of the PTZ camera.  
At PRELIST : You can control PTZ after selecting the Camera.



DVRLIST

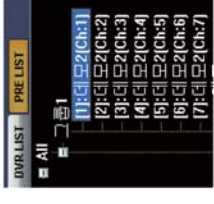

PRELIST

#### 8.4.5. Event Status

If you click EVENT button, you are able to check several types of event logs.



#### 8.4.6. CMS user setup

If you click  button, a window of user list will appear. You can manage users to access Client S/W by adding or deleting user.

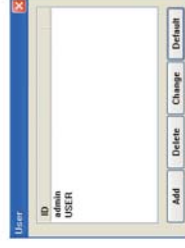

- ADD : add user
- DEL : delete registered user
- CHG : change user ID or Password
- Default : Delete all registered users except for admin user

#### 8.4.7. Snapshot

Select screen and click the snapshot button  to get a picture.



#### 8.4.8. Config

If you click Config  button, Config window pops up as below.

##### 8.4.8.1. OSD

You can select what you want to be shown in each channel as OSD.

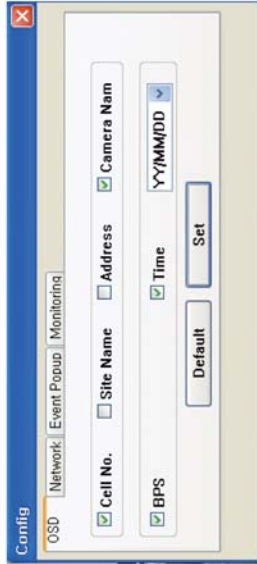

##### 8.4.8.2. Network

1) This function indicates that video will be hidden or not in Live Display mode.

If you select 'Covert OFF', video will not be showed same as you set it in local DVR.

##### 2) Waiting Time

Because of unstable network transmission, CMS will wait until the time what you set if CMS does not receive the data from DVR so, DVR will not give next data to CMS for this time you set.



##### 8.4.8.3. Event Popup

Event notification will be worked as 'Popup Video' 'Beep Sound' and 'High Light'.

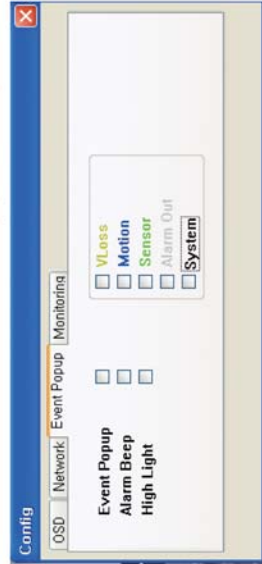

#### 1) Event Popup

When event triggered in local DVR, Video will be showed as full screen.  
(DVR should be set on EVENT Mode first )



#### 2) Alarm Beep

When Event triggered, it gives beep sound in CMS PC.

#### 3) High Light

The channel had Event is shown with the color on the border for following events such as 'Video Loss', 'Motion Detected' and 'Sensor Activated.



#### - Alarm Out

If you select Alarm out, CMS indicates it on Log window when Alarm out happens in DVR.

#### - System

If you select System, CMS indicates it on Log window when HDD is failed in DVR.

#### 4) Event Viewer

If you select the Event Viewer on the bottom of window, you can see the log information.

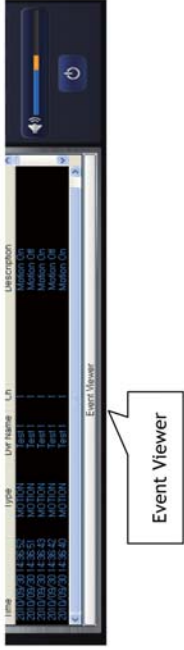

Logs on list can be saved or printed

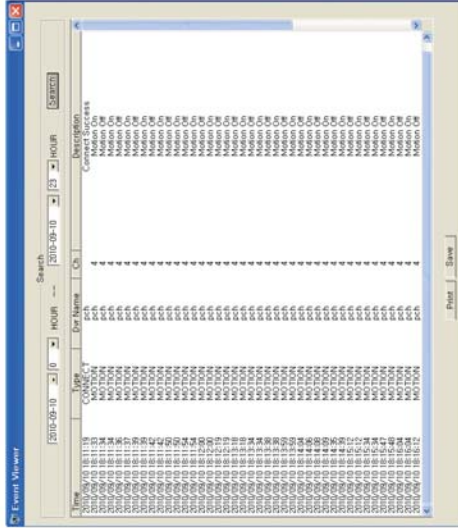

#### 8.4.8.4. Monitoring

Monitoring Rotating is sequence of channels. You can set up rotating time as seconds and this is how to use it. On initial screen mode, select auto change button and sequence mode gets activated. In case of 16ch DVR, if you select 4ch screen mode, it rotates by 4 channels. (1<sup>st</sup>: ch1,2,3,4 - 2<sup>nd</sup>: ch5,6,7,8 -) If you select 9ch screen mode, it rotates by 9 channels.

(1<sup>st</sup>: ch1,2,3,4,5,6,7,8,9 - 2<sup>nd</sup>: ch10,11,12,13,14,15,16,1,2 -)



#### 8.4.9. RPB (Remote Playback)

It is search function to playback recorded data of remote DVR you connect from CMS.

- (1) Select DVR site what you wish listed in 'DVR LIST' tap of main screen of CMS.
- (2) Click **RPB** button to move to remote playback mode.
- (3) Select data and time(hour/minute).
- (4) Then, click play button to play.

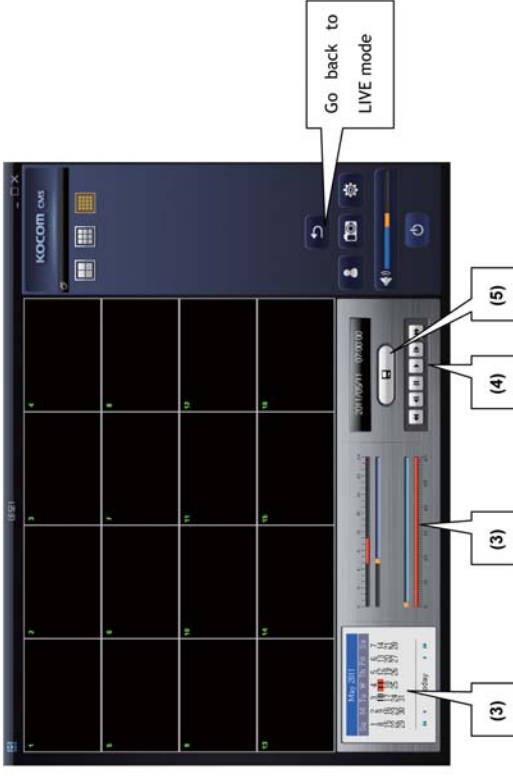

#### (5) Backup

- All channel backup

Click backup icon. Then select date and designate path to save backup file.

You will be able to see backup file lists by clicking Backup list button as below.

Select backup file on the list you wish to save and click Backup button.

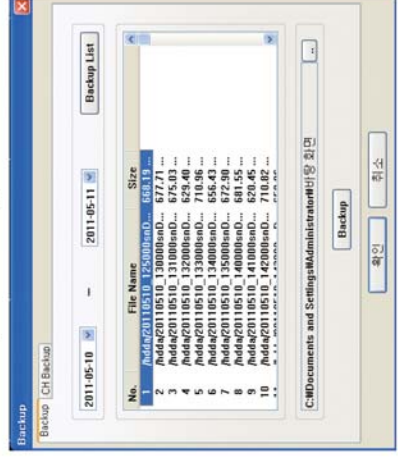

- Backup by each channel

Input Start time and End time. Select channel no. to backup and designate path to save file.  
Click CH Backup Start button to start CH backup.



#### 8.4.10. LPB(Local Playback)

It is search function to playback recorded data in your CMS PC which you backup in Setup mode.

(1) Click **LPB** button to move to backup player mode

(2) Click  button to open backup file.

\* It is possible to open over 1 file at a time.

(3) Click play button to check.

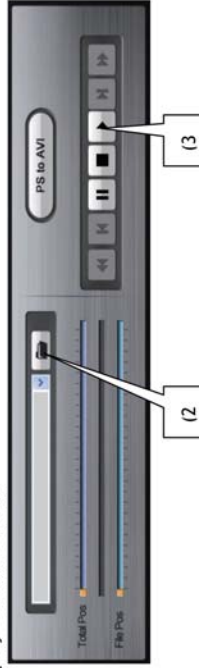

#### 8.4.10.1. Convert to AVI format

The format of backup file can be converted to AVI file per each channel.

If you Click PS to AVI ICON, the AVI Convert window will be shown.

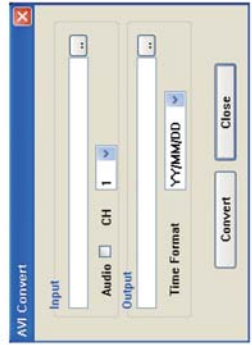

**Input** : Select backup file to convert to AVI

If you want to convert with Audio, check in Audio box

**CH** : Select channel to convert

**Output** : Appoint directory and file name

**Time Format** : Select time stamp be shown

**Convert** : Start AVI convert

#### 8.4.11. Remote setup

You can check or modify configuration of remote DVR using CMS.

Select DVR and click **SETUP** button to get into remote setup menu.

: LogView / Record Property / Net Property / Camera Name / Version / Remote Control / HDD

##### 8.4.11.1. Log view

You can search event logs by time and event type.



(1) Input time to search event logs

(2) Select event type

(3) Click Search button

##### 8.4.11.2. Record Property

You can check or modify recording setup values of remote DVR

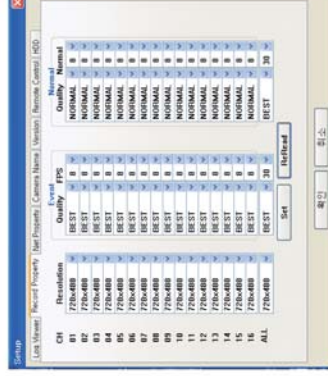

You can adjust resolution, Quality and frame rate to record.



### 8.4.11.3. Net Property

You can check resolution/quality/fps that remote DVR send via network.  
 \*Dual stream should be set "ON" to use this.



### 8.4.11.4. Camera Name

You can modify camera name as you wish.



### 8.4.11.5. Version

You can check DVR hardware information and firmware version.



### 8.4.11.6. Remote control

SW upgrade : F/W upgrade of remote DVR via CMS  
 Config Upload : You can change config data to DVR  
 Config Download : You can get config data from DVR  
 Remote Reboot : You can reboot DVR



### 8.4.11.7. HDD

You can check the number of HDD and HDD capacity installed in DVR



\*Specification

Specification	4 Channel DVR
Video	4
Audio	4
Sensor	1
Spot	1
10" LCD screen	1
AUDIO	1
Alarm(Relay)	1(1)
PORT	1 x USB port, 1 x PTZ(RS-485), 1 x Ethernet Port
Live	Digital Zoom X2 Monitoring Mode 1,4 & PIP
Resolution	NTSC - 720*480, PAL - 720 * 576
Recording	Frames at [CIF] 120 / 100 Frames at [H. D1] 120 / 100 Frames at [D1] 60 / 50
Pre/Post Rerecording	Pre (0 - 30 Seconds), Post (0-120 seconds)
Recording Mode	Manual/ Continuous/Schedule/Motion/Sensor
Speed	Fast Forward/Backward(x1/8/32/128), Frame by frame
Search Method	By time, Calendar, Events and Go to First/Last Data
Playback	Local Recording & Network Transmission
Network	Network Transmission rates max.30/25FPS at CIF Live/Playback/Audio/PTZ/Snapshot
Web (I.E)	Live/Playback/Backup/PTZ/Remote Setup
CMS	Support dnscctv.com/dyndns.com/no-ip.com
DDNS	
Mobile Viewer	3G Mobile Phones, iPhone, Android phone
Bandwidth	Adjustable (64/128/256/512Kbps,1/2/4/10Mbps, Unlimited)
Events & Video Loss	Email Notification, Alarm-Out, Buzzer for Events & Video Loss
Motion Detection	Selected Area, sensitivity in each channel
Scheduling	mail Notification Schedule/Alarm Schedule for Events-Trigger
Storage	SD card 32GB (SDHC)
OS	Linux
Control	Touch screen/direction keys
Backup Device	USB Memory Stick / USB HDD
User management	2 local users & 4 network users
Firmware Upgrade	USB flash memory, Network
Log View	System operation status

## Mobile Viewer in Smart phone

We support Mobile Viewer, named 'aViewer' for iPhone and 'DVRoid' for Android smart phones in order for you to access the DVR.

### 1. How to install

You can download and install aViewer(iPhone) / DVRoid(Android).

- 1) iPhone : Click App Store in iPhone -> Search "aViewer" -> Click "aViewer" free icon -> Click Install
- 2) Android : Click Market in Android -> Search "DVRoid" -> Click "DVRoid" free icon -> Click Install  
Then aViewer(iPhone)/ DVRoid(Android) icon will be created in your Mobile Phone.

### 2. How to start

- 1) iPhone



- 2) Android

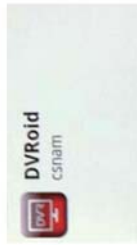

[Enter Login Password: default / Password : "admin"]

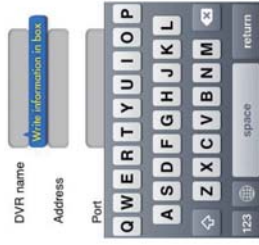

[Click icon]

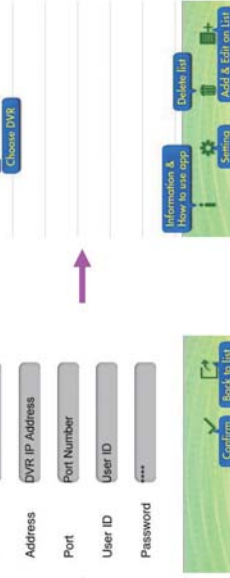

### 3. Edit DVR List

- 1) 'Edit DVR List' menu will be showed. You need to register DVR what you wish to access remotely.
  - DVR name: Input any name what you wish.
  - Address: Input DVR IP address or host name.
  - Port: Input DVR port number which same as DVR you set in Setup->Network->Client->Client Port.
  - User ID & Password: Input User ID and Password same as DVR you registered.

- 2) iPhone : if you click button, DVR List window will be showed with DVR name as you type.
  - : Save and return to DVR List menu - :Not save and return to DVR List menu
- 3) Android : if you click button, DVR List window will be showed with DVR name as you type.
  - : Save and return to DVR List menu - :Not save and return to DVR List menu

### 4. Mobile Viewer

- 1) iPhone : Click 'DVR Name' you created in DVR List, our mobile viewer will be showed as below.
- 2) Android : Click 'DVR Name' you created in DVR List and click button, our mobile viewer will be showed as below you created in DVR List



: zoom in in 1ch screen mode, : zoom out in 1ch screen mode

**CH-** : Changes channel to the very previous CH, **CH+** : Changes channel to the very next CH.

: 1ch screen mode, : 4ch screen mode, : 9ch screen mode, : 16ch screen mode

**Close** : close live screen

### 5. How to set & edit DVR List



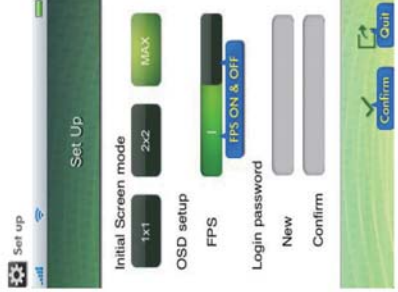
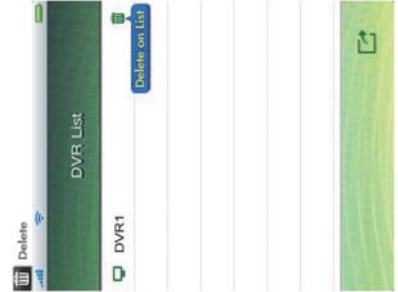

 :Version information

 :DVR list setup menu

 :Delete DVR name

 :Add/modify DVR name

## How to use photo converter



- 1) Double click on photo converter icon to start installation. Start program after installation and this is what it looks like.

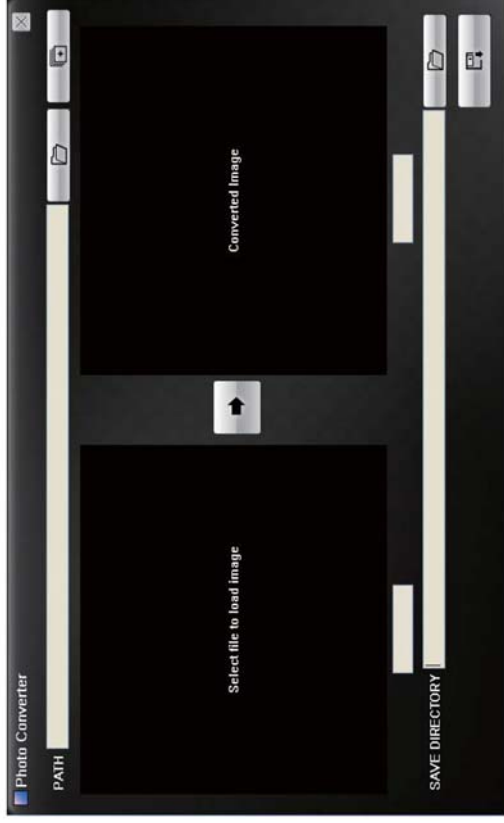

- 2) Click  button to designate path and open picture file that you wish to convert size. Then, picture image shows up on the left.

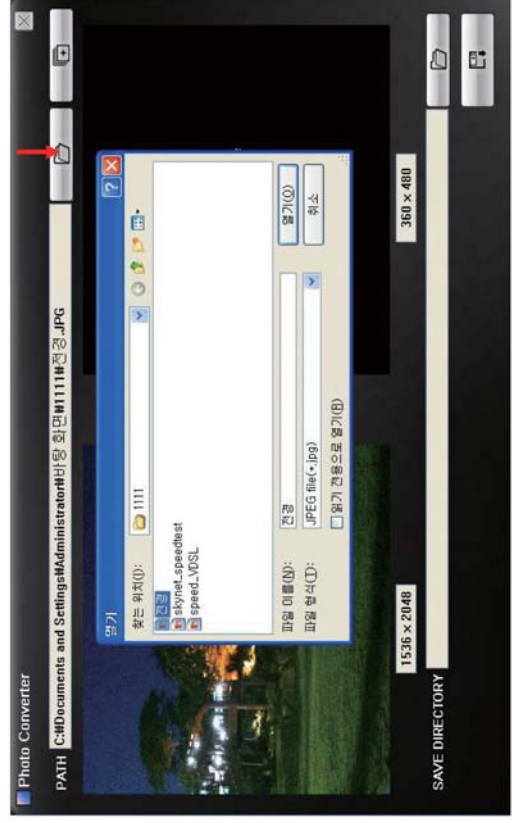

- 3) Click  button to convert file size. You can check converted size on the right.

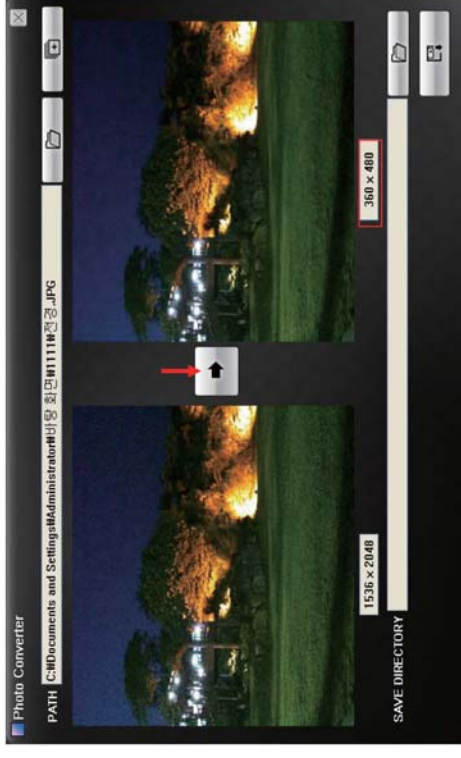

- 4) Click  to designate SAVE DIRECTORY and click  button. Then, converted file is saved in the designated SAVE DIRECTORY.

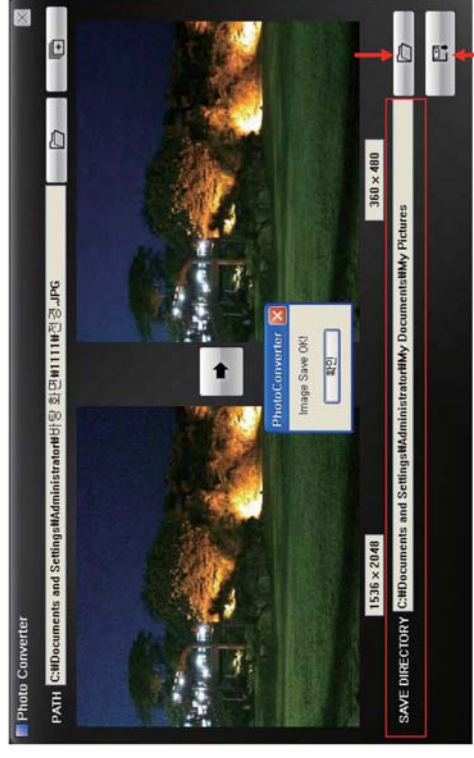

- 5) In case there are picture files more than 1, click  button and select all the files you wish to convert. Designate SAVE DIRECTORY and click  button. Then, all the selected files will be converted at a time. Click  button to stop converting in progress of convert.

