

# Chapa magnética doble de 1200LBS

## Modelo: MAG1200NDLED

### Especificaciones

Dimensiones	530Lx73Wx41H (mm)
Fuerza de sujeción	1200Lbs(500Kgs) x2
Voltaje	12V CD o 24V CD
Corriente	12V/500mA o 24V/250mA x2
Para uso en	Puerta de seguridad, puerta de hierro, puerta de aluminio.
Temperatura de operación	-10~+55°C
Peso	9Kg

### Diagrama

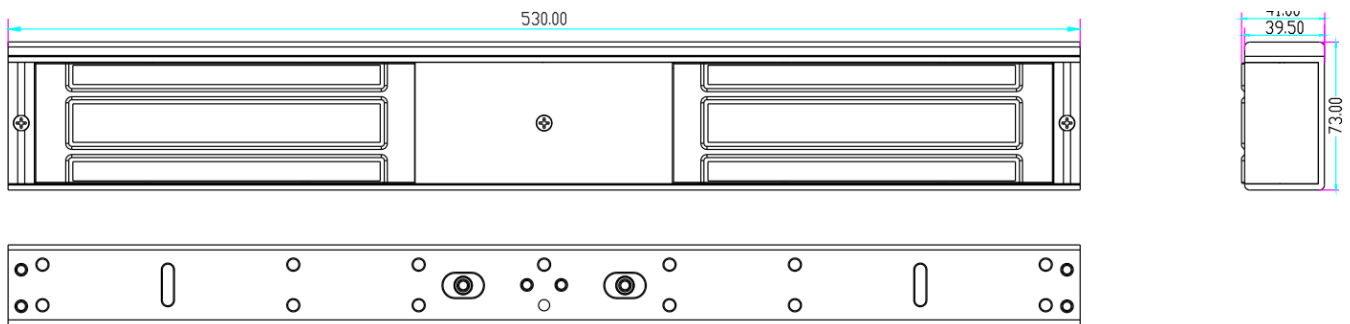

Pasos de instalación:

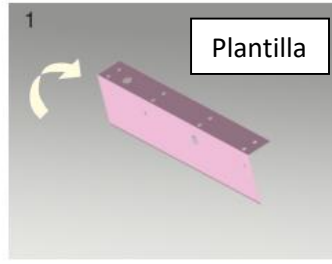
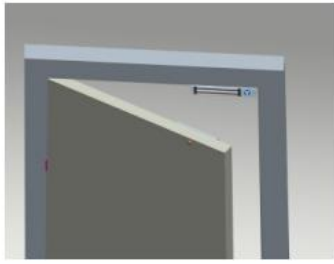

Doblar la plantilla.

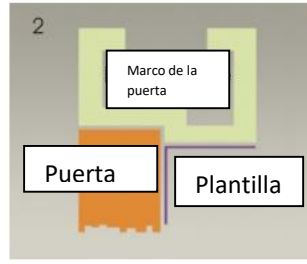

Cierre la puerta y ajuste la platilla.

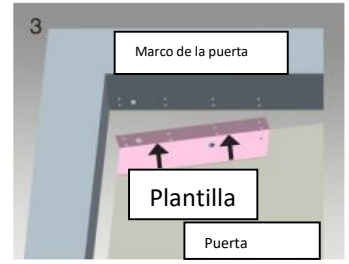

Perforar usando la plantilla.

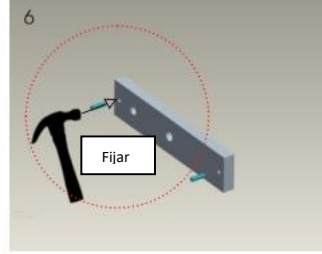
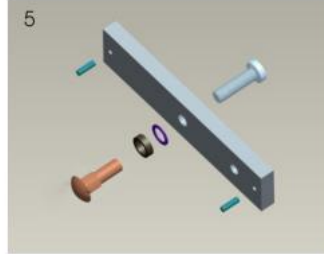
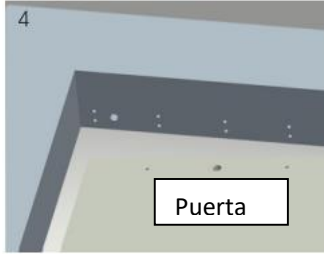

Fije los pines.

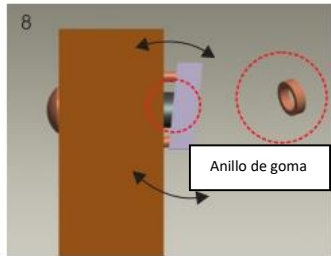
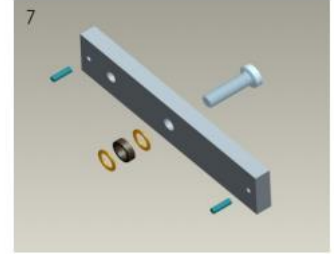

Coloque el anillo de goma entre la placa y la puerta.

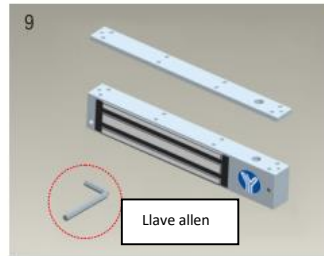

Desmonte el montaje en "1".

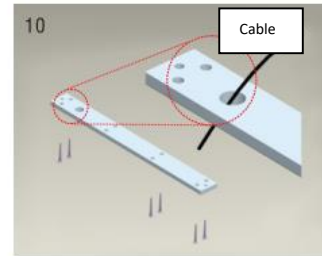

Acomode el cable por la perforación

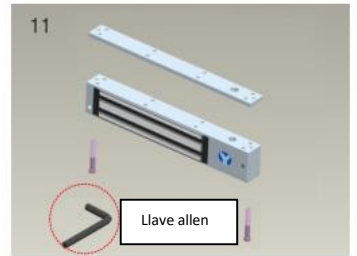

Ajuste los opresores con la llave.

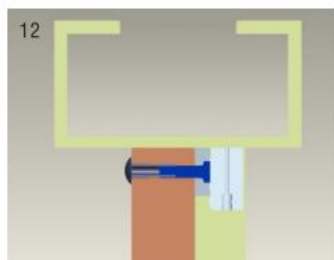

Cierre la puerta para probar la fuerza de sujeción. El ángulo entre la placa y el magnético se puede ajustar agregando o reduciendo las arandelas.

Terminales de conexión

