

THIS DRAWING CONTAINS INFORMATION PROPRIETARY TO RF INDUSTRIES,
 ANY UNAUTHORIZED USE OF THIS DRAWING IS EXPRESSLY PROHIBITED
 WITHOUT WRITTEN PERMISSION FROM RF INDUSTRIES.
 ANY VIOLATION IS PUNISHABLE UNDER U.S. COPYRIGHT LAWS.

ALL DIMENSIONS ARE REFERENCE ONLY

PART NO.

RP-3252-1C1

REV	DESCRIPTION	DWN	DATE	APPROVED
-	ENGINEERING RELEASE	CZS	4/13/00	JDMc
A	CHANGE STRIPPING DIMENSIONS	CZS	10/30/06	JDMc

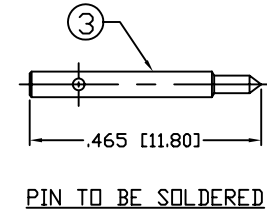
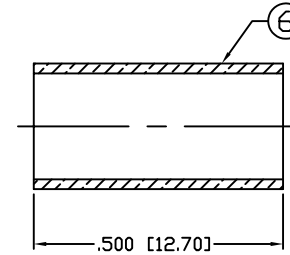
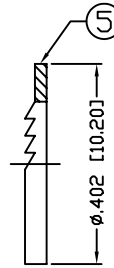
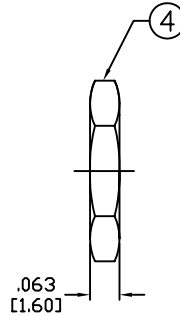
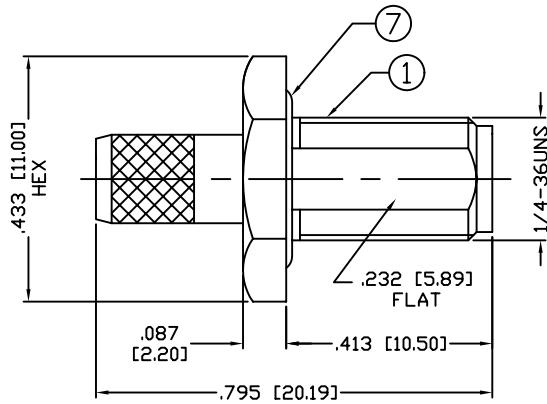

RECOMMENDED CRIMP DIE: .213"

PIN TO BE SOLDERED

SPECIFICATIONS:

IMPEDANCE: 50 Ohms
 FREQUENCY RANGE: 0-12.4 GHz
 VSWR: 1.3 MAX.
 WORKING VOLTAGE: 500 V rms Max. @ Sea Level
 INSULATION RESISTANCE: 5k M Ohms min.
 TEMPERATURE RANGE: -65°C TO 85°C
 FOR RG-55, 55A, 55B, 142, 142A, 142B, 223 & 400/U,
 ALPHA 9055, 9055B, 9223, BELDEN 8219, 83242, 84142

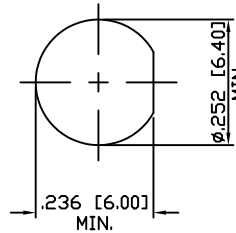

RECOMMENDED MOUNTING HOLE

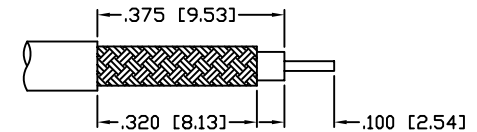

RECOMMENDED STRIPPING DIMENSIONS

1	BODY	1	BRASS	GOLD, 3μ"	007777	
2	INSULATOR	1	PTFE	----		
3	PIN	1	BRASS	GOLD, 50μ"		
4	HEX NUT	1	BRASS	GOLD, 3μ"		
5	WASHER	1	BRASS	GOLD, 3μ"		
6	FERRULE	1	BRASS	GOLD, 3μ"		
7	O-RING	1	SILICONE	----		
8						
9						
10					DRAWN	
11					C. ZUNIGA	
12					CHECKED	
13					10/30/06	
14					ORJ DRAWN	
					C. ZUNIGA	
					4/13/05	
#	DESCRIPTION	QTY	MATERIAL	FINISH	APPROVALS	DATE

UNLESS OTHERWISE SPECIFIED:

 DIMENSIONS ARE IN INCHES
 AND [MILLIMETERS]
 UNLESS OTHERWISE NOTED
 TOLERANCES ARE:
 DECIMALS DIAMETER

RF connectors
 DIVISION OF RF INDUSTRIES, LTD.
 7610 MIRAMAR RD
 SAN DIEGO, CA 92126
 (858) 549-6340
 (858) 549-6345 FAX

SMA JACK, CRIMP

REVERSE POLARITY, BULKHEAD

SIZE	CABLE GROUP	DWG NO.	REV
A	C1	RP-3252-1C1	A
SCALE:	NTS	CAD FILE	OUTLINE
		SHEET	1 OF 1